

# Thermal In Situ Energy Benchmarking Study Report



**Prepared for**

**Canada's Oil Sands Innovation Alliance  
(COSIA)**

**August 2014**

**JACOBS** Consultancy

*This document, and the opinions, analysis, evaluations, or recommendations contained herein are for the sole use and benefit of the contracting parties. There are no intended third party beneficiaries, and Jacobs Consultancy shall have no liability whatsoever to third parties for any defect, deficiency, error, omission in any statement contained in or in any way related to this document or the services provided.*

205 Quarry Park Boulevard SE  
Calgary, Alberta T2C 3E7  
Canada  
+403.258.6896 (phone)  
+403.385.1543 (fax)

# Thermal In Situ Energy Benchmarking Study Report

Prepared For

## Canada's Oil Sands Innovation Alliance (COSIA)

For Jacobs Consultancy,



**Laura E. Weaver**



**Bill Keesom**



**John Gieseeman**



**Rich Hill**

**August 2014**

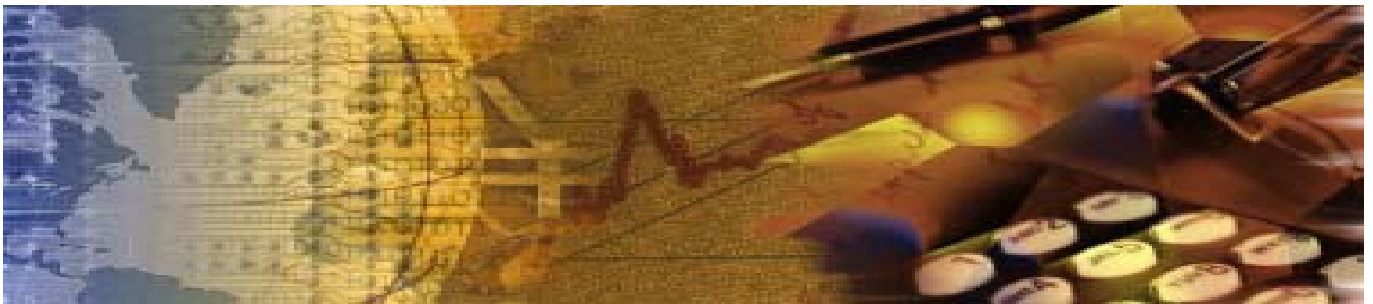
This report was prepared based in part on information not within the control of the consultant, Jacobs Consultancy Canada Inc. Jacobs Consultancy has not made an analysis, verified, or rendered an independent judgment of the validity of the information provided by others. While it is believed that the information contained herein will be reliable under the conditions and subject to the limitations set forth herein, Jacobs Consultancy does not guarantee the accuracy thereof. Use of this report or any information contained therein shall constitute a release and contract to defend and indemnify Jacobs Consultancy from and against any liability (including but not limited to liability for special, indirect or consequential damages) in connection with such use. Such release from and indemnification against liability shall apply in contract, tort (including negligence of such party, whether active, passive, joint or concurrent), strict liability or other theory of legal liability, provided, however, such release limitation and indemnity provisions shall be effective to, and only to, the maximum extent, scope, or amount allowed by law.

This document, and the opinions, analysis, evaluations, or recommendations contained herein are for the sole use and benefit of the contracting parties. There are no intended third party beneficiaries, and Jacobs Consultancy shall have no liability whatsoever to third parties for any defect, deficiency, error, omission in any statement contained in or in any way related to this document or the services provided.

# Table of Contents

<b>Executive Summary</b> .....	<b>1</b>
Study Basis .....	2
COSIA Vision .....	3
Problem Statement.....	3
Highlights .....	4
Conclusions .....	10
<b>Introduction</b> .....	<b>13</b>
Purpose .....	14
Scope of the Study.....	16
Participant Sites .....	17
Ground Rules .....	18
<b>Methodology</b> .....	<b>19</b>
Data Collection.....	20
Data Analysis .....	20
Potential In Situ Benchmarking Metrics.....	35
<b>Results</b> .....	<b>37</b>
Mass Balance.....	39
Energy Balance.....	40
OTSG Efficiency.....	42
Energy Consumption.....	44
Electricity Consumption.....	49
Major Quantifiable Losses.....	50
GHG Emissions.....	63
Major Factors Affecting GHG Emissions.....	67
<b>Conclusions</b> .....	<b>73</b>
Benchmarks .....	74
Observations .....	75
<b>References</b> .....	<b>77</b>
<b>Appendix</b> Data Requested from Study Participants.....	<b>79</b>

## Section 1.



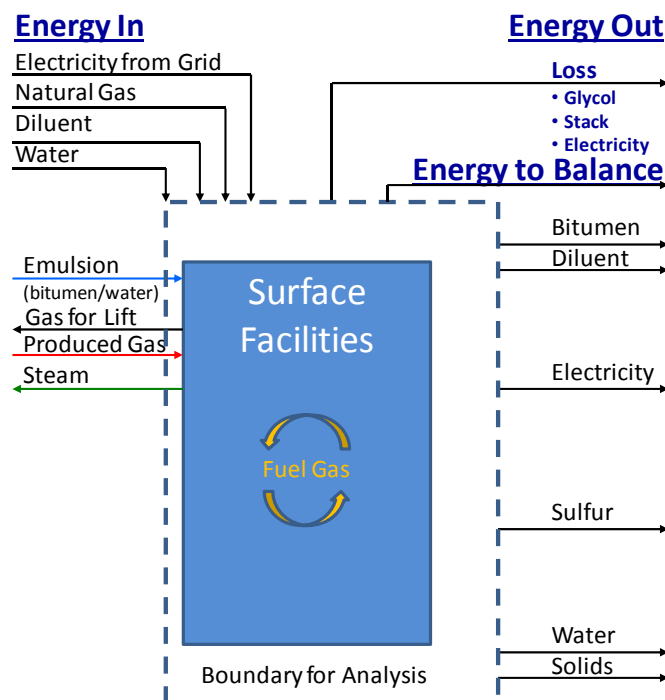
## Executive Summary

# Study Basis

Canada's Oil Sands Innovation Alliance (COSIA) contracted Jacobs Consultancy Canada Inc. (Jacobs Consultancy) to establish benchmarks for evaluating the energy efficiency of thermal in situ bitumen production facilities. These benchmarks will enable producers to compare energy consumption and GHG emissions between their own production sites and the average energy consumption and GHG emissions of all the sites evaluated in the Study.

One of the key objectives of the Study was to establish a clear and transparent methodology that isolates the impact of the reservoir and eliminates the impact of electricity generated on site and exported to the grid. Energy efficiency benchmarks will enable comparison of energy efficiency of sites with different Central Processing Facility (CPF) designs, bitumen lift mechanisms, reservoir pressures, and reservoir geologies. Energy efficiency benchmarking will enable monitoring of facility performance over time, better quantify the impact of technology, design, and operation, and help establish industry best practices. A schematic of the Study boundaries is shown in Figure 1.1.

**Figure 1.1**  
**Study Scope and Boundaries**



The energy balance around the CPF can be simply expressed as follows:

$$\text{Energy}_{\text{In}} = \text{Energy}_{\text{Out}} + \text{Losses}$$

Energy In and Energy Out are determined by the flow of energy in the streams entering and leaving the CPF. Losses are a result of thermodynamic losses incurred in steam generation and electricity generation as well as losses to the glycol system used in heat transfer between streams in the CPF. In addition, there may be other losses—for example, losses through piping insulation—that are not easily quantified.

Study results are based on monthly operating data from six commercial Steam Assisted Gravity Drainage (SAGD) sites and one Cyclic Steam Stimulation (CSS) site. Most sites provided at least one year of operating data and many provided as much as three years of data. In executing the Study we filtered the data as necessary to eliminate outlying or inconsistent data.

## **COSIA Vision**

COSIA's vision is “to enable responsible and sustainable growth of Canada's oil sands while delivering accelerated improvement in environmental performance through collaborative action and innovation.”

The Study is one such example of collaborative action aimed at understanding GHG performance among the in situ operators to benchmark performance and determine if there are best practices that can be adopted throughout the industry.

## **Problem Statement**

The in situ production of bitumen via SAGD or CSS is energy intensive. It requires a large amount of thermal energy in the CPF to generate steam and requires electrical energy in the CPF to move fluids. Because energy consumption in the CPF is highly dependent on the amount of steam required to produce bitumen from the reservoir, which is in turn highly dependent on the reservoir properties, significant improvements in energy consumption and reduction in GHG emissions are difficult.

Differences in reservoir geology between sites result in differences in steam to oil ratio (SOR), which affects the energy consumption to produce a barrel of bitumen and makes it difficult to compare CPF energy efficiency and GHG emissions. Steam-to-oil ratio is the ratio of the cold-water-equivalent volume of steam (condensate) to the volume of bitumen produced. However,

by putting the energy consumption and GHG emissions on the basis of steam consumption, it is possible to compare sites and thereby develop industry benchmarking criteria.

COSIA commissioned the Study to understand the state of the thermal in situ bitumen production industry in terms of energy consumption and generation of GHG emissions and to determine if there are sufficient differences between the operators to identify best practices that could be used to improve the industry's GHG emissions performance.

## Highlights

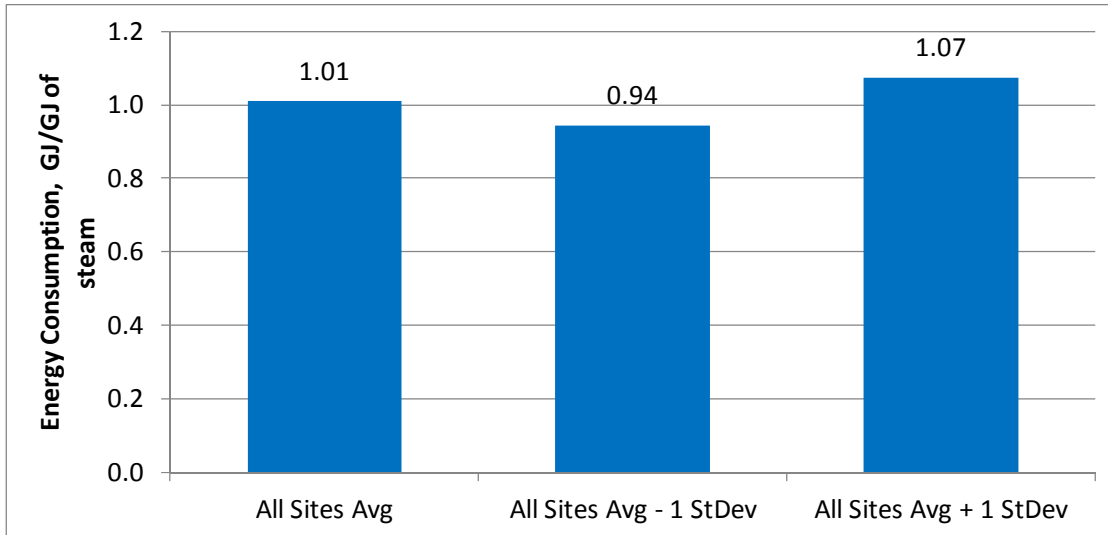
Energy consumption is dependent on the efficiency of steam generation, the efficiency of electricity generation, and the amount of heat that can be recovered from the emulsion entering the CPF from the reservoir – greater recovery of heat from the emulsion to the boiler feed water (BFW) results in less fuel needed to generate steam. GHG emissions are dependent on energy consumption and the type of energy used – natural gas has lower GHG intensity than the coal used to generate nearly 50% of the electricity for the Alberta grid; syngas has higher GHG intensity than natural gas.

Energy consumption, GHG emissions, and losses that occur in steam generation, in electricity generation and transmission, and in the glycol system are key metrics of in situ production of bitumen. The challenge in the Study was to determine these metrics from each site's operating data and then with confidence develop overall benchmarking metrics for the sites in the Study that could be used to direct the reduction in energy consumption and GHG emissions.

The study identified significant differences in the performance of the various operators in terms of the energy consumption and GHG emissions required to produce an equivalent amount of steam thermal energy. We found that the energy consumption required to produce a GJ of steam differs 13% from one standard deviation below the mean energy consumption to one standard deviation above the mean energy consumption. Figure 1.2 shows the average energy consumption in the CPF and also the energy consumption  $\pm$  one standard deviation from the average.

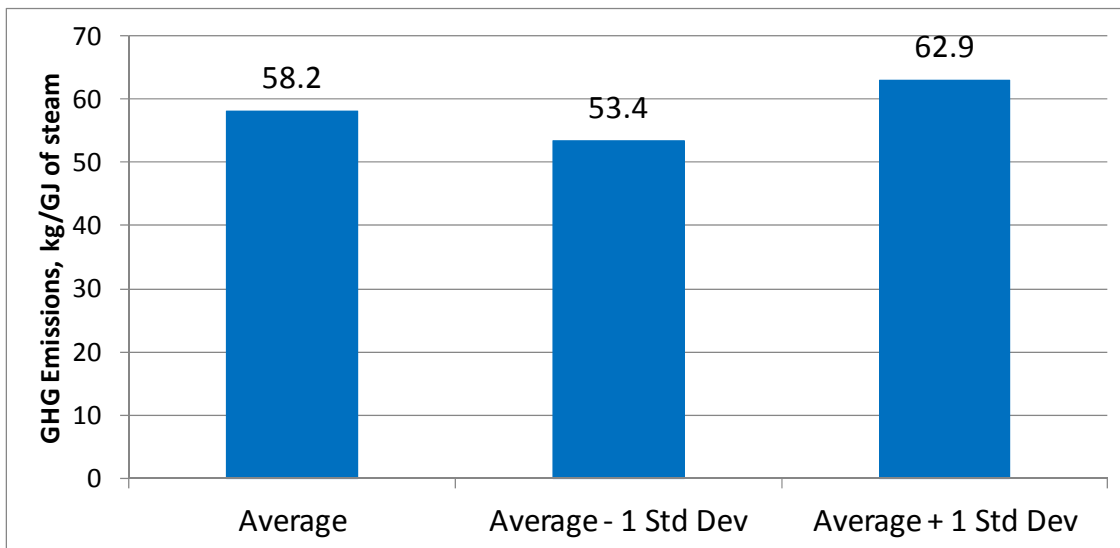


**Figure 1.2**  
**Energy Consumption per GJ of Steam—All Sites**



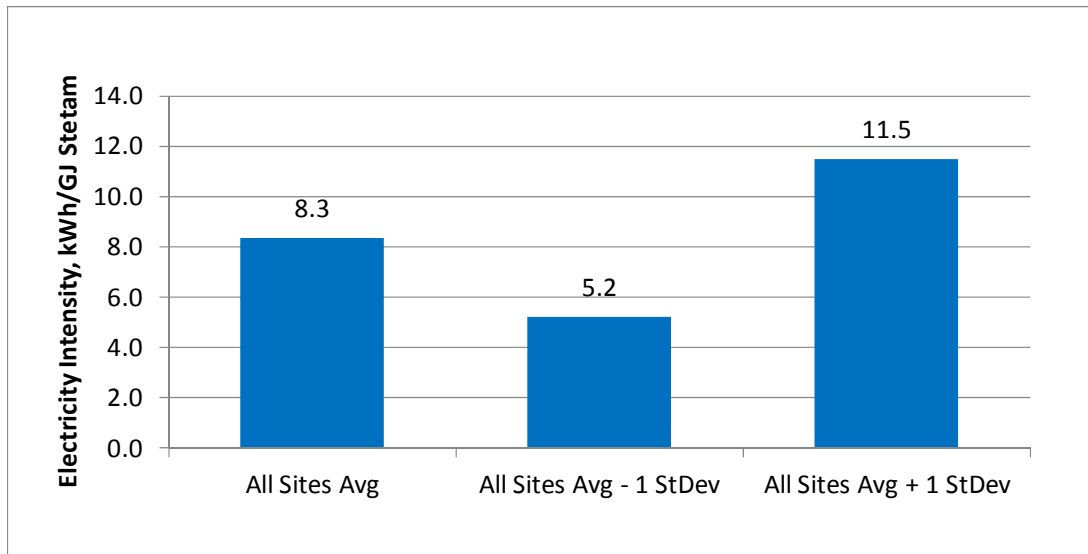
Likewise, as shown in Figure 1.3, we found that the difference in GHG emissions to produce a GJ of steam varied by 16% between sites that were one standard deviation below the mean and one standard deviation above the mean of 58.2 kg CO<sub>2</sub>/GJ of steam. For this analysis, we replaced the GHG intensity of syngas with the GHG intensity of natural gas to enable sites using syngas to be included in comparing GHG emissions.

**Figure 1.3**  
**GHG Emissions per GJ of Steam—All Sites, Syngas Replaced with Natural Gas**



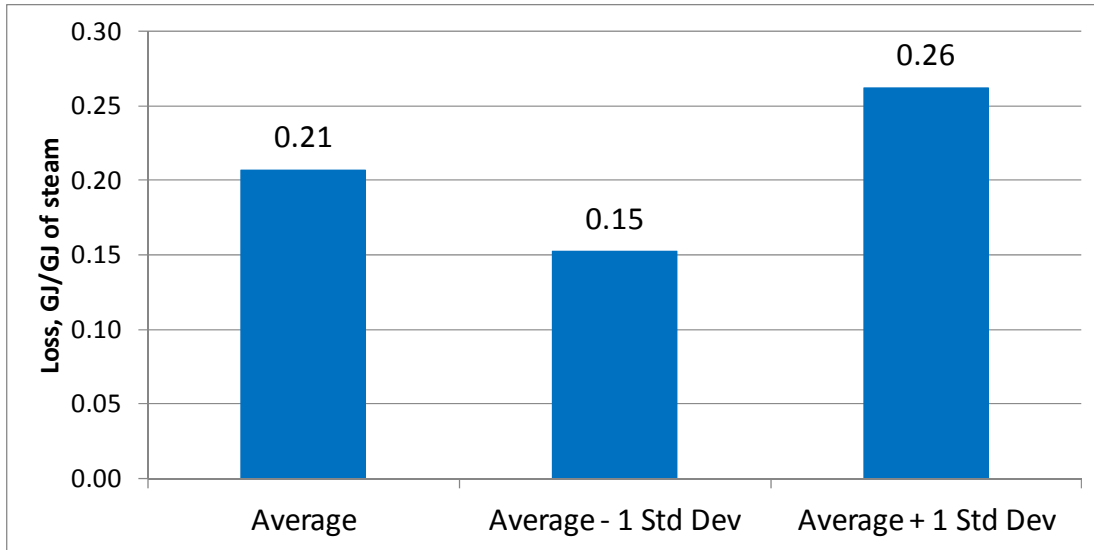
There are significant differences in electricity consumption in the CPF. Figure 1.4 shows that the average electricity consumption to produce a GJ of steam is 8.3 kWh/GJ of steam with a standard deviation of 3.1 kWh/GJ of steam, which is 38% of the average electricity consumption. The span from one standard deviation below the average to one standard deviation above the average is 75% of the average, a significant difference.

**Figure 1.4**  
**CPF Electricity Consumption per GJ of Steam—All Sites**



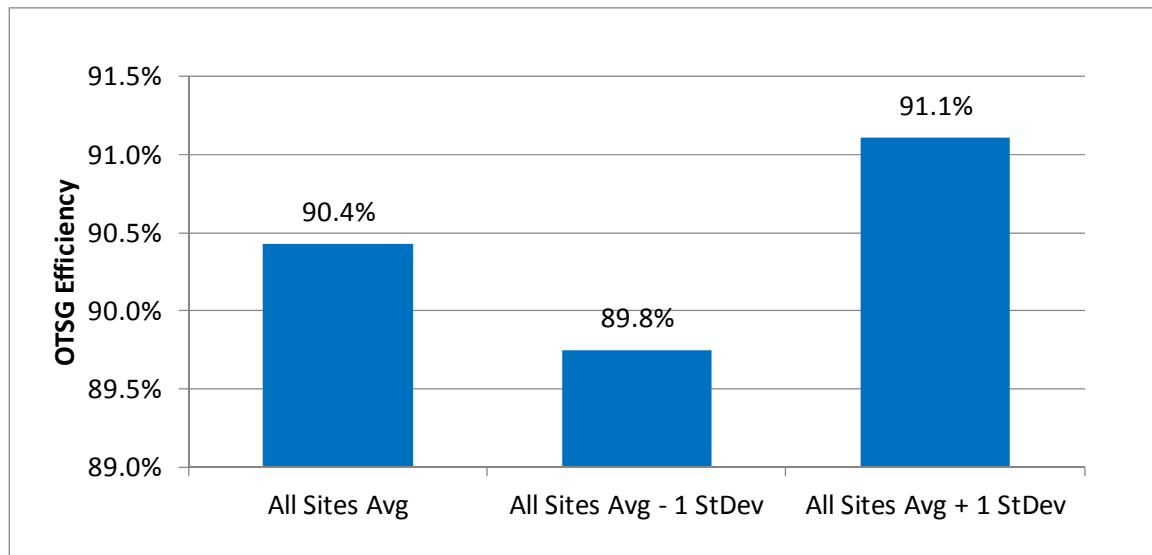
Quantifiable losses from the CPF include energy loss to the once-through steam generator (OTSG) stacks, energy loss from electricity consumption, and energy loss to the glycol system. As shown in Figure 1.4, average overall loss for all sites is 0.21 GJ/GJ of steam with a standard deviation of 0.06 GJ/GJ of steam, which is 27% of the average or 53% for the span from one standard deviation below the average to one standard deviation above the average. These differences are significant.

**Figure 1.5**  
**Quantifiable Losses per GJ of Steam in the CPF—All Sites**



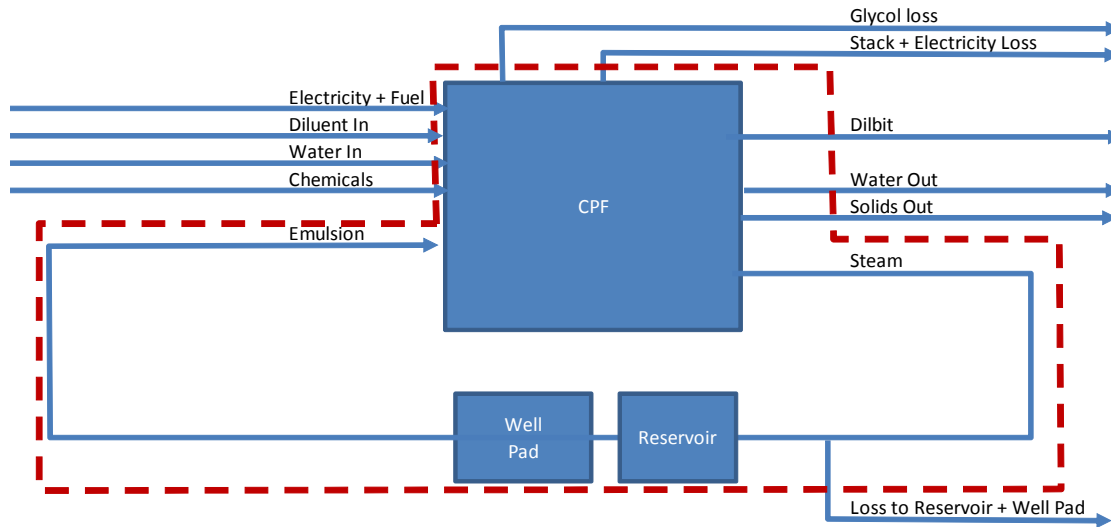
We did not see much difference in the efficiency of OTSGs between sites. The average efficiency of the OTSGs, shown in Figure 1.6 was 90.4% with a standard deviation of 0.7%, which is less than 1% of the average.

**Figure 1.6**  
**OTSG Efficiency—All Sites**



We also evaluated the overall energy balance around in situ bitumen production shown in a simplified schematic in Figure 1.7. The dotted red line highlights the boundary for analysis.

**Figure 1.7**  
**CPF Energy Balance—Simplified Schematic**

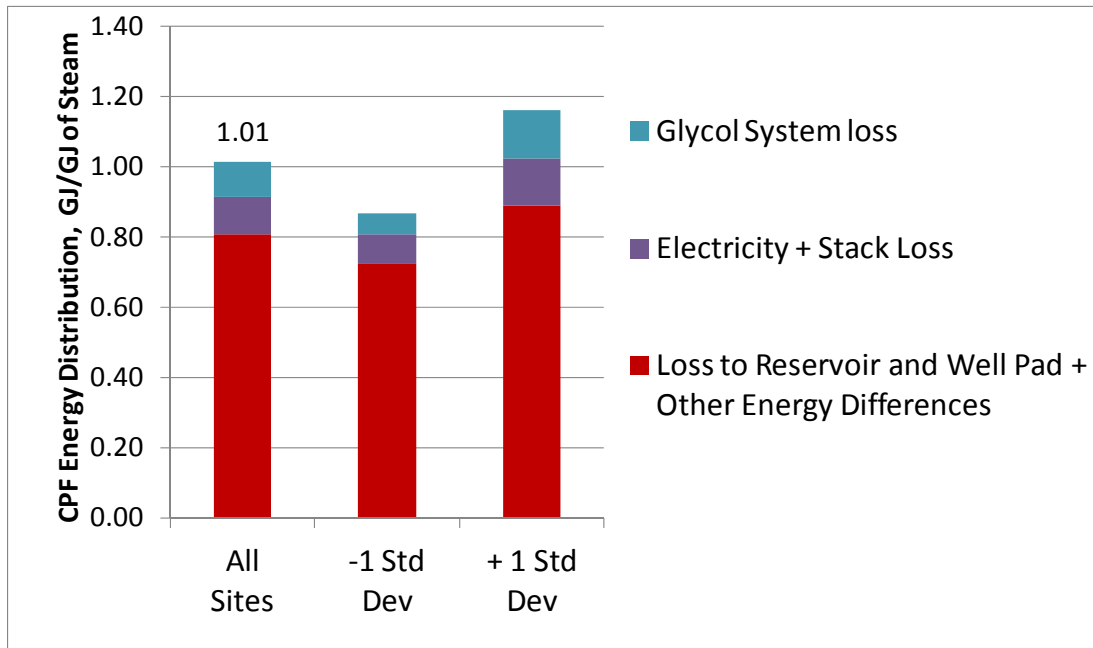


The energy into the CPF in terms of electricity and fuel minus the quantifiable losses to the glycol system, to the stack, and to electricity can be used to solve for loss to the reservoir and well pad plus the energy in the water and dilbit out minus the energy in the water in and diluent in.

$$\text{Energy}_{(\text{Electricity} + \text{Fuel})} - \text{Losses}_{(\text{Glycol and to Stack} + \text{Electricity})} = \text{Loss}_{(\text{Reservoir} + \text{Well Pad})} + \text{Energy}_{(\text{Dilbit})} - \text{Energy}_{(\text{Diluent})} + \text{Energy}_{(\text{Water Out})} - \text{Energy}_{(\text{Water In})}$$

The distribution of energy used in the CPF is shown for all sites in Figure 1.8. The term loss to reservoir and well pad plus other energy differences in Figure 1.8 is the overall average energy used in the CPF (Figure 1.2) minus the average losses to the glycol system and electricity plus stack loss. We have included in Figure 1.8 two additional bars based on  $\pm$  one standard deviation from the average values shown in the left most bar for each parameter: glycol loss; electricity + stack loss; and loss to reservoir and well pad. The variation in losses is significant.

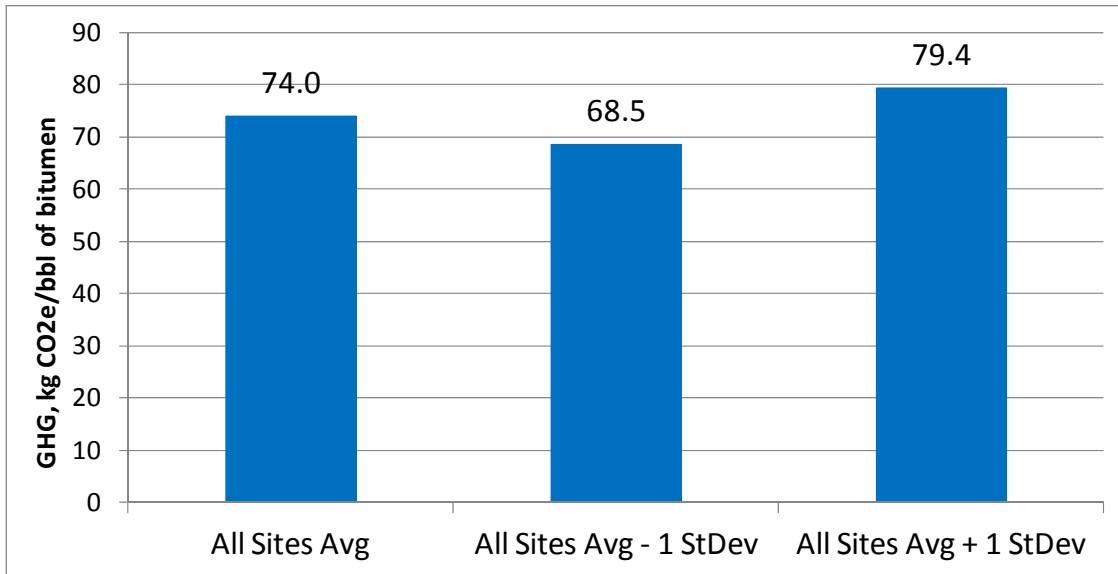
Figure 1.8  
CPF Balance—All Sites on Average



Comparing GHG emissions between sites to produce a barrel of bitumen is difficult because they use different SORs as a result of different reservoir geologies. In addition, there are differences in the steam injected in SAGD and CSS sites – SAGD sites inject saturated steam; CSS sites inject steam plus water. Thus the reported SORs are on different bases for SAGD and CSS sites.

In Figure 1.9 we estimated GHG emissions on average for all the SAGD sites at a nominal 3 SOR. The results show the GHG emissions to produce a barrel of bitumen is 74 kg CO<sub>2</sub>/bbl of bitumen on average with a standard deviation of 5.4 kg CO<sub>2</sub>/bbl of bitumen, 7% of the average. To include sites using syngas, we replaced the GHG intensity of syngas with the GHG intensity of natural gas.

**Figure 1.9**  
**GHG per bbl of Bitumen at a Nominal 3.0 SOR—SAGD Sites**



## Conclusions

A summary of overall conclusions about in situ benchmarks and observations from the Study follow.

### Benchmarks

- Benchmarks were put on the basis of a GJ of steam generated in order to eliminate the effect of the reservoir and also eliminate the effect of steam properties. By using this basis, we can compare results from all sites irrespective of SOR or steam quality. Thus, sites that must operate at higher SOR to produce bitumen because of reservoir geology may be compared with sites that can operate with lower SOR. Also, sites that inject a water-steam mixture (CSS sites) can be compared with sites that inject dry steam (SAGD sites). In addition, the effect of steam pressure is eliminated because the comparison uses steam enthalpy from steam tables.
- The average OTSG efficiency for all sites is 90.4% on a lower heating value (LHV) basis with a standard deviation of 0.7%, which is 0.7% of the average.
- The average energy consumption is 1.01 GJ (LHV) per GJ of steam for all sites and the standard deviation is 0.06 GJ/GJ of steam, which is 6% of the average.

- There is a significant difference in electricity consumption between sites: 8.3 kWh/GJ of steam, with a standard deviation of 3.1 kWh/GJ of steam, which is 38% of the average.
- The average total loss (stack loss + electricity loss + glycol system loss) is 0.21 GJ/GJ of steam and the standard deviation is 0.05 GJ/GJ of steam, which is 27% of the average. For SAGD sites, the magnitude of glycol loss is approximately equal to the magnitude of stack + electricity loss.
- The average of the GHG emissions for all sites is 58.2 kg CO<sub>2</sub>/GJ of steam, with a standard deviation of 4.8 kg CO<sub>2</sub>/GJ of steam, which is 8% of the average. For this estimate, we assumed natural gas GHG intensity for syngas.
- The average GHG emissions for the SAGD sites at a nominal 3 SOR is 74 kg CO<sub>2</sub>/bbl of bitumen with a standard deviation of 5.4 kg CO<sub>2</sub>/bbl, which is 7% of the average. This estimate assumes natural gas GHG intensity for syngas GHG intensity.

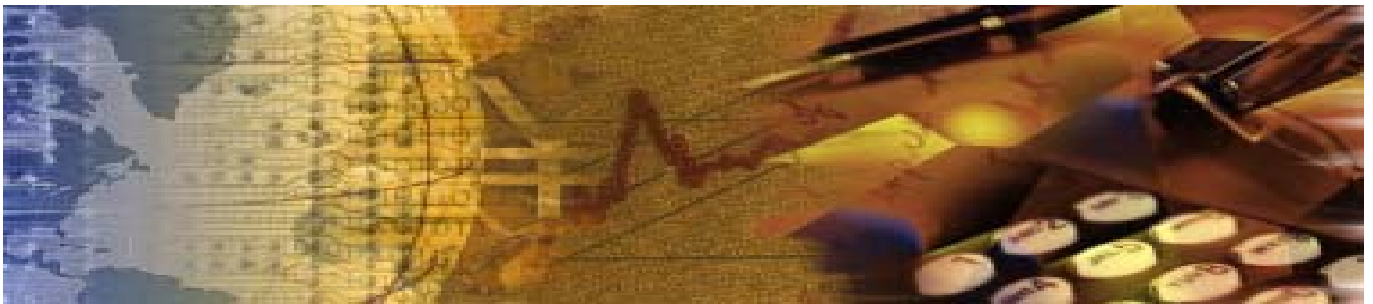
## Observations

- SOR is by far the biggest driver of GHG emissions and energy intensity. However, there are CPF operators that operate with higher efficiency than others.
- Preliminary evaluation of efficiency points to differences in facility design as opposed to variability in operations/maintenance. Overall, consistency in operation at a site was not necessarily an indicator of good performance in terms of energy consumption and GHG emissions. However, sites that demonstrated greater variability in performance tended to show greater variability in energy consumption and GHG emissions.
- OTSG efficiency is similar between sites. The narrow variability in OTSG efficiency indicates that although steam generation is the primary energy consumer in the CPF, variance within the range of OTSG efficiencies in the Study does not significantly affect GHG emissions. Thus, variability in OTSG stack losses is primarily due to variability in steam absorbed duty rather than variability in OTSG efficiency.
- Electricity consumption varied significantly between sites. The method of electricity generation and intensity of electricity consumption per GJ of steam has a small but not insignificant impact on GHG emissions.
- Better recovery of heat will lead to lower energy consumption and lower GHG emissions. Using electric submersible pumps in place of gas lift to recover the bitumen-water emulsion from the reservoir will reduce energy use and GHG emissions at the CPF because more energy in the emulsion can be recovered. Reducing losses to the glycol system will lead to lower energy consumption and GHG emissions.

- Using on site cogenerated steam and electricity leads to lower GHG emissions than using grid-based electricity and generating steam in an OTSG because cogenerated steam and electricity generation are more efficient and the natural gas fuel is lower in GHG emissions than the fuels used to generate electricity for the grid.
- Variability in overall quantifiable losses is primarily due to variability in glycol system loss and stack loss, indicating differences in configuration, losses, and energy recovery from the emulsion.
- We did not see the expected relationships between BFW temperature and energy consumption or between BFW temperature and steam absorbed duty. We suggest that this indicates that the measurement of one or more parameters, likely BFW temperature, is not accurate enough for a correlation to be observed at most sites and is a result of inconsistency in the location of measurement or that the water economizers on the boilers offset differences in BFW preheat. We recommend sites examine the placement and accuracy of BFW temperature measurement.



## Section 2.



## Introduction

## Purpose

Canada's Oil Sands Innovation Alliance (COSIA) contracted Jacobs Consultancy Canada Inc. (Jacobs Consultancy) to establish benchmarks for evaluating the energy efficiency of thermal in situ bitumen production facilities. These benchmarks will enable producers to compare energy consumption and greenhouse gas (GHG) emissions between their own production sites and with the average energy consumption and GHG emissions for all sites evaluated in the Study.

One of the key objectives of the Study was to establish a clear and transparent methodology that isolates the impact of the reservoir and eliminates the impact of electricity generated on site and exported to the grid. Energy efficiency benchmarks will enable comparison of energy efficiency of sites with different Central Processing Facility (CPF) designs, bitumen lift mechanisms, reservoir pressures, and reservoir geologies. Energy efficiency benchmarking will enable monitoring of facility performance over time as well as better quantify the impact of technology and regulation.

In situ production of bitumen via thermal means is generally broken down into three distinct areas: the reservoir, the well pad, and the surface facilities, which include the CPF. Typically, steam is generated in the CPF, transported to the well pad via pipeline, and injected into the reservoir to heat the bitumen. The resulting bitumen/water emulsion recovered from the reservoir is sent to the CPF for treatment. The water is separated from the bitumen and further treated for reuse in generating steam; some water makeup is required to replace water lost to the reservoir, lost to blowdown in steam generation, or in solids disposal. Bitumen is combined with a naphtha-based diluent during this processing, and more diluent may be added to facilitate pipeline transport. There is significant heating and cooling of streams in bitumen production via thermal means. A schematic of fluid flow and heat transfer is shown in Figure 2.1 for a typical Steam Assisted Gravity Drainage (SAGD) production site (bitumen production via Cyclic Steam Stimulation [CSS] has similar processing steps). The amount of heating, cooling, and losses in bitumen production depends on the design of the facilities, the reservoir, and the steam-to-oil ratio (SOR) used. Steam-to-oil ratio is the ratio of the cold-water-equivalent volume of steam (condensate) to the volume of bitumen produced.

Figure 2.2 shows the major areas of energy transfer and losses occurring in SAGD bitumen production. This figure shows losses for a typical design of a well pad and surface facilities, for one with a more efficient design, and for one that uses new technology, such as optimized heat integration, to reduce energy loss. Note that energy loss to the reservoir is the biggest factor, followed by loss to the heater stacks, and then heat loss to the air coolers. Better technology and more efficient designs can reduce stack loss and air cooler loss. However, losses to the reservoir are less amenable to reduction.

Figure 2.1  
Schematic—Energy Transfer in Hypothetical SAGD Facility

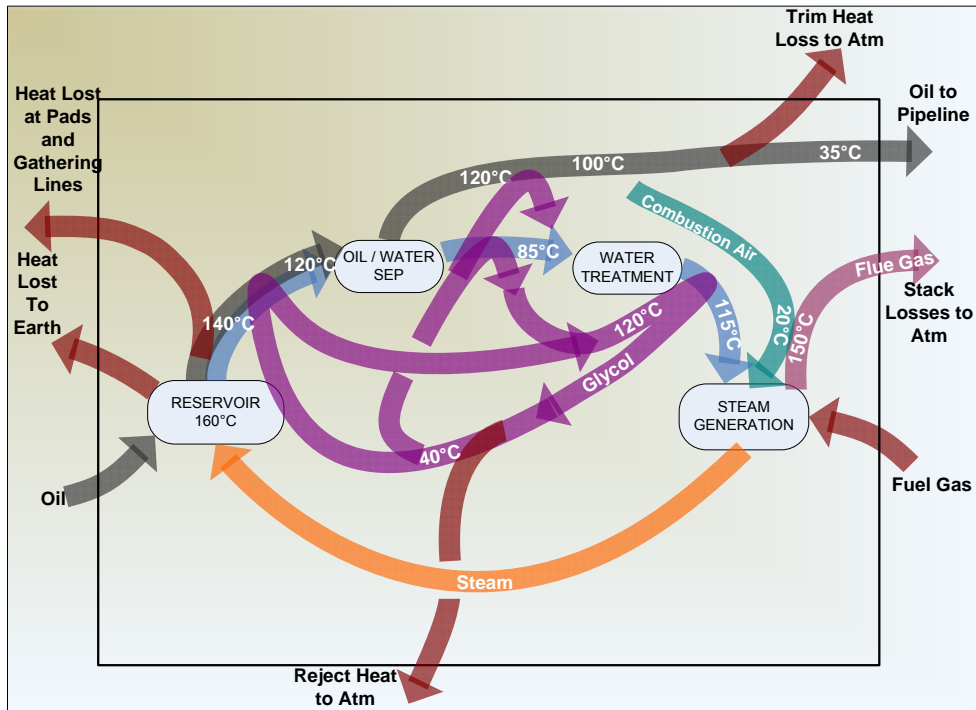
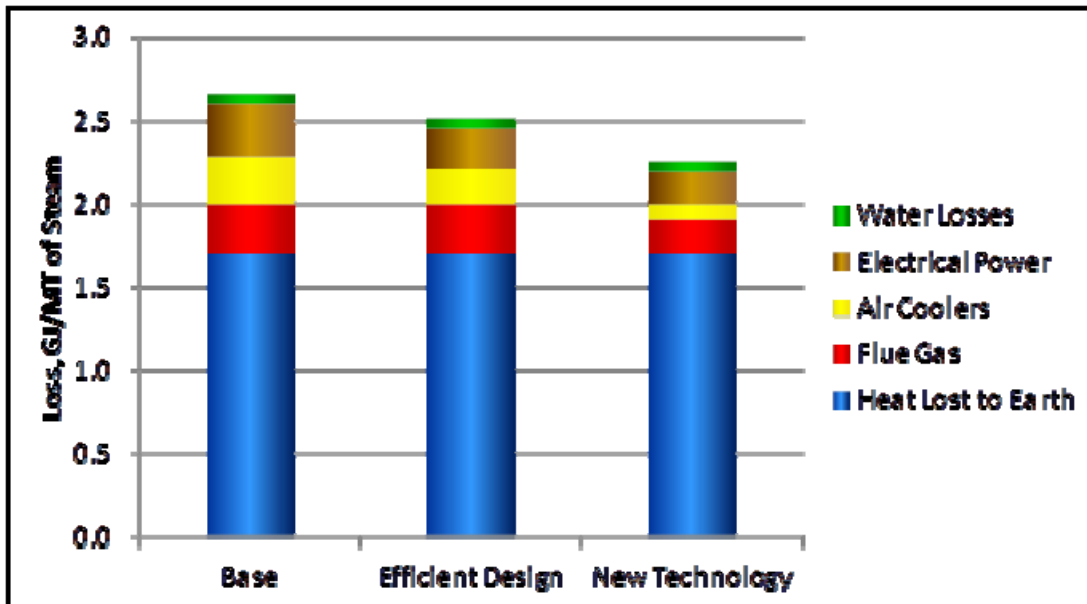


Figure 2.2  
Schematic—Energy Transfer in Hypothetical SAGD Facility



This document, and the opinions, analysis, evaluations, or recommendations contained herein are for the sole use and benefit of the contracting parties. There are no intended third party beneficiaries, and Jacobs Consultancy shall have no liability whatsoever to third parties for any defect, deficiency, error, omission in any statement contained in or in any way related to this document or the services provided.

The Study objectives were as follows:

- Benchmark the energy efficiency and GHG emissions of commercial thermal in situ bitumen production sites
  - Help each operator compare operation of their facilities against industry averages
  - Prepare energy efficiency metrics for the industry
  - Develop sufficient detail to help each operator better understand and monitor the performance at each of their facilities
- Separate the impact of the reservoir
  - SOR needed to produce bitumen
  - Amount of water consumed or produced
  - Amount of gas produced

We evaluated three measures of energy efficiency:

- Loss from air cooling
- Loss from the heater stacks
- Loss from electricity generation and delivery to the site

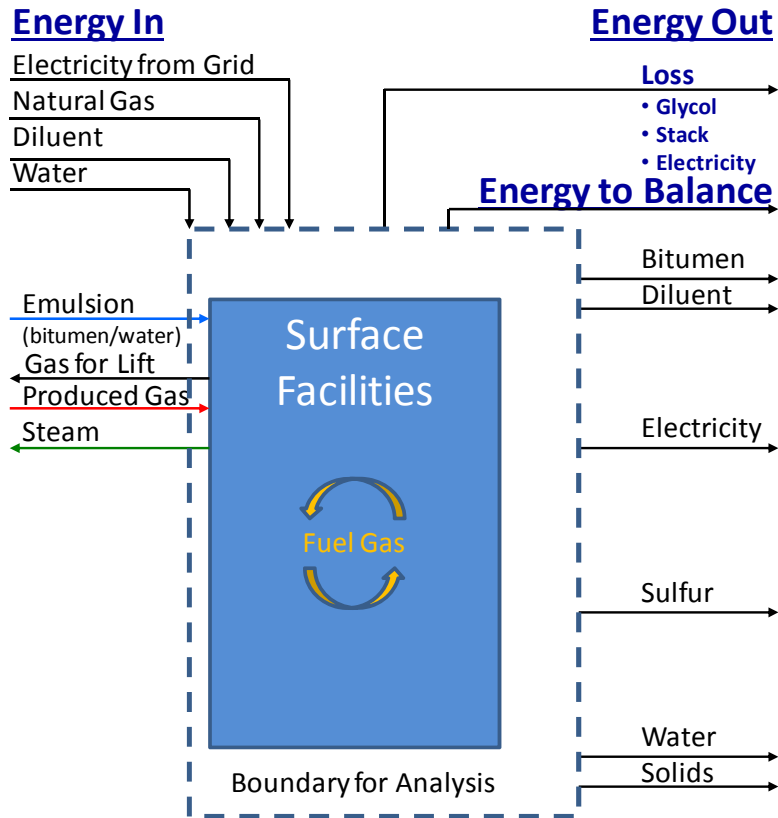
Energy consumption, GHG emissions, and loss will be put on the basis of the energy content of steam used for in situ bitumen production, which minimizes the effect of SOR and steam properties.

## Scope of the Study

At the kickoff meeting, the study team consisting of COSIA, the study members, and Jacobs Consultancy decided not to include the reservoir in the Study. In addition, over the course of the Study, it became apparent that information needed to include the impact of the well pad was lacking. The operators that were queried as to the availability of well pad data indicated that it was not available and/or was produced from instruments that were not well calibrated. In addition, these data would come from multiple sources, because many well pads supply a single CPF and each well pad is supplied by multiple wells. Also, the energy losses at the well pad were estimated to be much smaller than the losses and energy consumption at the CPF, where steam is generated. As a result, the study team concluded that the effort to collect the well pad data would be significant and of less value than collecting and evaluating data from the CPF.

Thus, the study team decided that the surface facilities at the well pad would be out of scope for this Study. Instead, the Study focused on measuring performance of the CPF, the major consumer of energy for thermal in situ bitumen production. The boundaries of the Study and the major energy and mass streams in and out of the CPF are shown in the schematic in Figure 2.3.

**Figure 2.3**  
**Study Scope and Boundaries**



The Study deliverables include development of energy and GHG emissions benchmarks for thermal in situ bitumen production, based on all the sites in the Study. In addition, each Study participant would receive a more detailed comparison of results from their sites with the overall energy and GHG emissions benchmarks.

## Participant Sites

The sites whose operators provided data for the Study are detailed in Table 2.1. The participating sites include six SAGD facilities and one CSS facility. There are four sites where the primary electricity source is the Alberta grid and three where the primary source of electricity

is onsite cogeneration of electricity and steam. A description of the sites in the Study is in Table 2.1.

**Table 2.1  
Participant Sites**

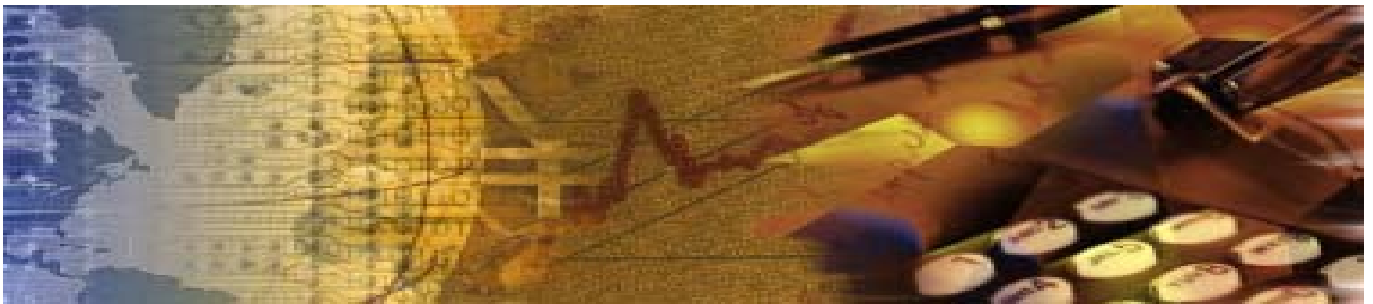
Operator	Plant	Type	Primary Electricity Source
ConocoPhillips	Surmont 1	SAGD	Grid
CNRL	Primrose South, Primrose North, Primrose East, and Wolf Lake (evaluated as a single site due to combined surface facilities)	CSS	Onsite cogeneration
Devon	Jackfish 1	SAGD	Grid
Devon	Jackfish 2	SAGD	Grid
Nexen	Long Lake	SAGD with upgrader	Onsite cogeneration
Statoil	Leismer	SAGD	Grid
Suncor	Firebag	SAGD	Onsite cogeneration

## Ground Rules

The team established the following ground rules for the Study:

- The evaluation should be rigorous and transparent
- Benchmarking should isolate the impact of the reservoir on energy and cogeneration
- The evaluation should capture all heat transfer across the Study boundaries
- The Study should identify data gaps
- The Study should go into sufficient detail to get meaningful energy efficiency comparisons

## Section 3.



## Methodology

## Data Collection

Jacobs provided each participant with a list of parameters and data required for the Study (Appendix 1). Monthly operating data for three years was requested. Some sites provided data for this period. All provided data for at least one year. Some sites provided daily or weekly data, which we converted into monthly averages.

## Data Analysis

Data from each site was used to estimate the energy and mass balances and losses to the Once-Through Steam Generator (OTSG), to the glycol system, and to electricity generation and consumption.

## Data Gaps

Some sites were not able to provide data for each requested parameter. Values for crucial missing data were estimated based on engineering judgment of industry trends, from trends for similar data within the information provided from the site, or from other provided parameters. We consulted with the sites when these assumptions were made.

## Mass and Energy Balance

The starting point for the analysis is a determination of the mass and energy balance for the process. The mass balance can be expressed as follows:

$$\text{Mass Balance} = \text{Mass In} - \text{Mass Out}$$

The mass balance includes the streams shown in Table 3.1:



**Table 3.1  
Mass Balance Streams**

Mass In	Mass Out
Emulsion	Steam
Diluent	Dilbit
Produced Gas (if separate from Emulsion)	Produced Gas
Makeup Water	Disposal Water
	Sulfur (if applicable)
Chemicals In *	Solids Out*

\*Chemicals in and solids out are assumed to be roughly equal and therefore cancel each other out in the mass and energy balances.

The energy balance can be expressed as follows:

$$\text{Energy Balance} = \text{Energy In} - \text{Energy Out} - \text{Losses}$$

Overall Energy Consumption =

Lower heating value (LHV) of natural gas/produced gas/syngas burned in OTSGs, glycol heaters, and cogen

- + LHV of fuel used to generate imported electricity
- LHV of fuel used to generate exported electricity (cogen only)
- LHV of fuel used to generate electricity for equipment outside the boundary of the CPF, such as electric submersible pumps (ESPs)

The energy balance includes the streams listed in Table 3.2 and defined below:

**Table 3.2  
Energy Balance Streams**

Energy In	Energy Out & Losses
Emulsion	Steam
Diluent	Dilbit
Makeup Water	Produced Gas
Natural Gas	Disposal Water
Produced Gas (if separate from Emulsion)	Electricity to Utilities
Electricity Imported from the Grid (Fuel Value)	Electricity Exported
	OTSG Stack Losses
	Electricity Generation Losses (Imported and/or Cogen)
	Glycol Heater Losses
	Glycol Cooler Losses

- Fuel gas energy: includes the produced gas, natural gas, and other gases consumed at the CPF, based on lower heating value (LHV) and gas flow rate
- Electricity imported from the grid
- Process stream energy: based on the flow rate and change in enthalpy at flowing conditions vs. enthalpy at 0°C as a reference condition
- Electricity to utilities: the difference between total electricity consumed and the estimated electricity consumed by the boiler feed water (BFW) pump; the energy used in pumping ends up in the stream that is pumped
- Electricity exported from the site
- Losses to the OTSG stacks, to the glycol heaters and coolers, and losses in electricity generation and transmission

The energy in each stream is based on the enthalpy of the stream and flow rate. The sites reported flow rates and temperature of emulsion, dilbit, and glycol over time. We calculated the enthalpy of the stream based on the heat capacity and temperature of the stream. The properties of emulsion, dilbit, and glycol can be estimated from the individual component properties (water, bitumen, diluent, and glycol) and the proportion in each mixture.

Electricity from the grid is expressed as the fuel to generate and distribute the required electricity used in the CPF. Electricity loss is the difference between the energy used to generate the electricity used in the CPF and the electricity consumed in the CPF. It includes line losses to transport electricity from the point of generation to the CPF.

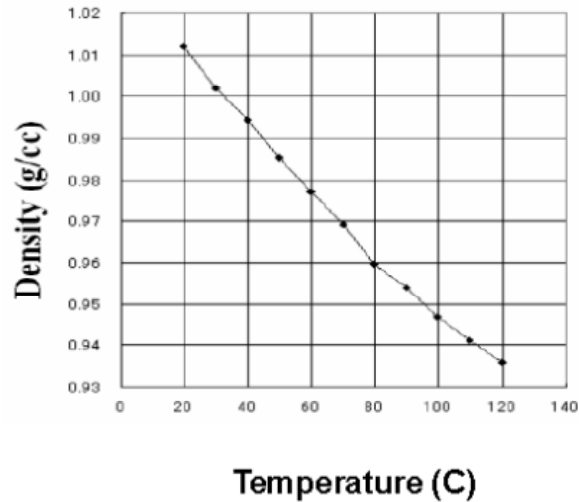
## Properties

To determine the energy in the emulsion, dilbit, and glycol, we first estimated the properties of streams at flowing conditions. Heat capacity and density change with temperature.

## Bitumen Density

We used the relationship between Athabasca bitumen density and temperature shown in Figure 3.1 from Mochinaga (1).

**Figure 3.1**  
Athabasca Bitumen Density vs. Temperature



The bitumen density in this figure is around 8.5 API gravity. The results can be fit to the following line:

$$\rho \text{ Bitumen, Athabasca (kg/m}^3\text{)} = -0.83 \cdot T^{\circ}\text{C} + 1028$$

### Diluent Density

Diluent density, like bitumen density, decreases with temperature. The relationship of density with temperature is shown in Figure 3.2 for mid-boiling jet fuels, JP-4 and JP-5 (3). JP-4 is a 50/50 naphtha/kerosene blend jet fuel. It has the same slope of density vs. temperature as JP-5, a kerosene-based jet fuel. For the Study, we assumed the slope for diluent density vs. temperature will be the same as for mid boiling jet fuels: 0.78. We estimated the intercept for diluent based on diluent density at temperature reported by a site.

Figure 3.2  
Mid-Boiling Range Hydrocarbon Stream Density vs. Temperature

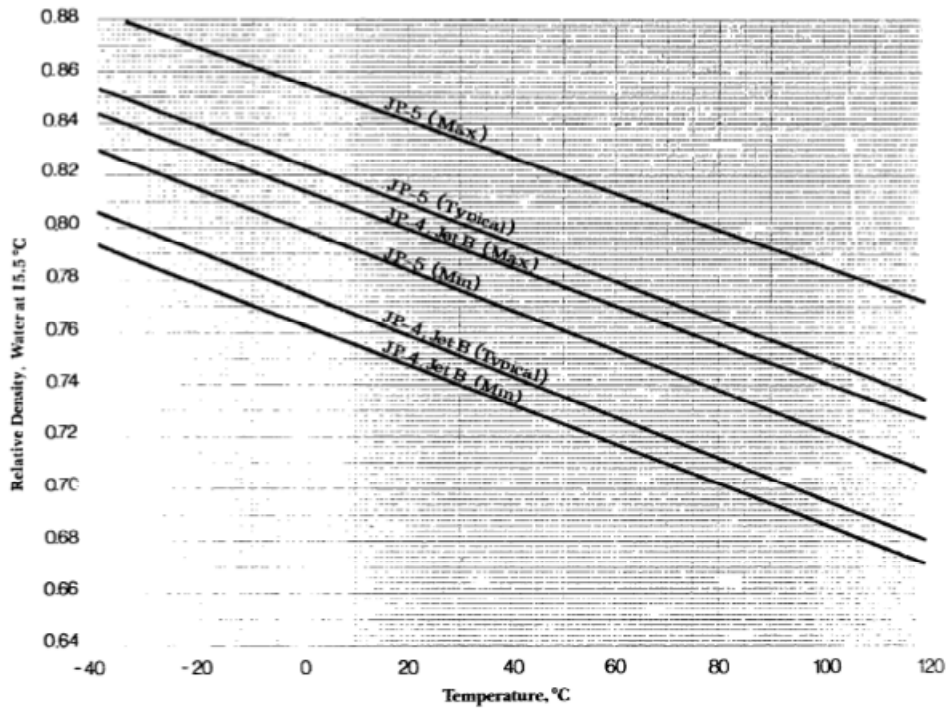


Figure 5  
Relative Density vs. Temperature (Max., Min., Typical)

## Heat Capacity of Hydrocarbons

The heat capacity ( $C_p$ ) of a hydrocarbon stream varies with temperature. The following correlations can be used to estimate the change in heat capacity as a function of temperature:

- Kesler and Lee Method (2)

$$C_p^L = a(b + cT) \quad (1.35)$$

$$a = 1.4651 + 0.2302 K_w \quad (1.36)$$

$$b = 0.306469 - 0.16734 SG \quad (1.37)$$

$$c = 0.001467 - 0.000551 SG \quad (1.38)$$

- API Method (2)

$$C_p^L = A_1 + A_2 T + A_3 T^2 \quad (1.39)$$

$$A_1 = -4.90383 + (0.099319 + 0.104281 SG) K_w \quad (1.40)$$

$$+ \left( \frac{4.81407 - 0.194833 K_w}{SG} \right)$$

$$A_2 = (7.53624 + 6.214610 K_w) \cdot \left( 1.12172 - \frac{0.27634}{SG} \right) \cdot 10^{-4} \quad (1.41)$$

$$A_3 = -(1.35652 + 1.11863 K_w) \cdot \left( 2.9027 - \frac{0.70958}{SG} \right) \cdot 10^{-7} \quad (1.42)$$

- Simple Method (3)

$$C_p \text{ (BTU/lb } ^\circ\text{F)} = 1/SG \cdot (0.388 + 0.0045 \cdot T_F(^{\circ}\text{F}))$$

SG is specific gravity at 60 °F

$K_w$  is the Watson K, which is  $(T_b)^{(1/3)}/SG$

T is °K (Kelvin)

$T_b$  is °R (Rankine) is the mid boiling point of the oil

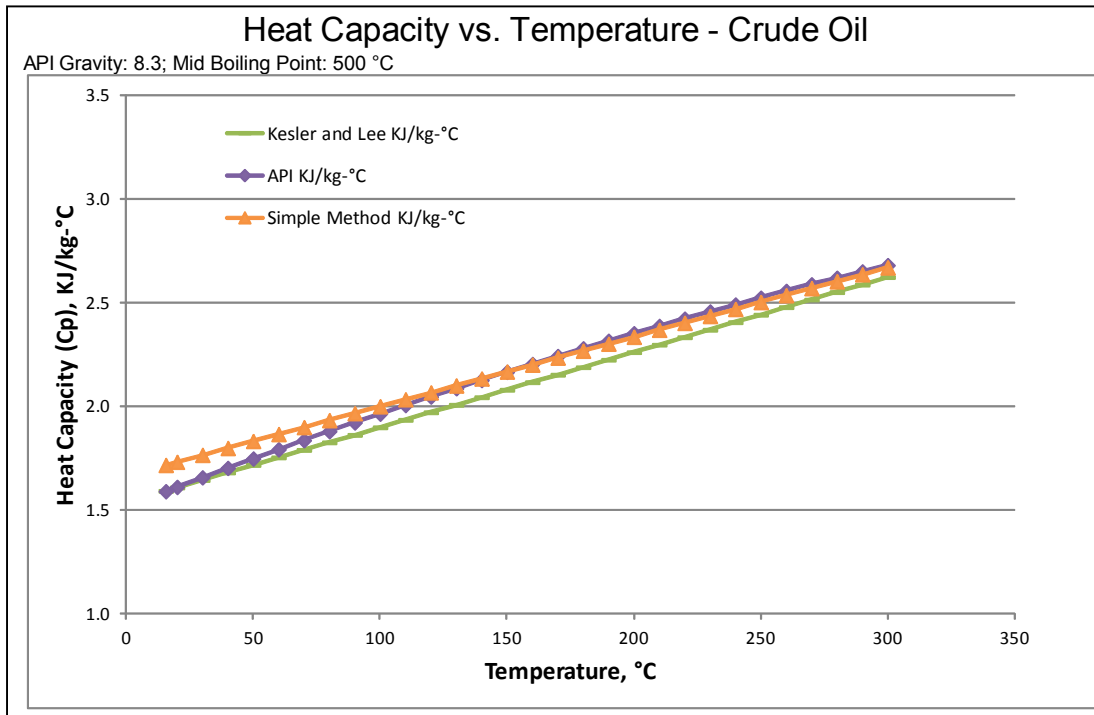
$T_F$  is °F (Fahrenheit)

To calculate  $C_p$  via the Kesler and Lee or API methods use T in °Kelvin

To calculate  $C_p$  via the Simple Method use T in °F

A comparison of heat capacity from the different correlations is shown in Figure 3.3. For the Study, we chose to use the Simple Method because it is a less complex equation and does not require knowledge of the boiling point of the stream. Results show minimal differences between  $C_p$  from the Simple Method and from the API or Kesler and Lee methods over the range of temperatures of interest in the Study.

**Figure 3.3**  
**Comparison of Methods to Determine Bitumen Heat Capacity vs. Temperature**



### Glycol Properties

Glycol is a mixture of water and glycol. Most bitumen producers use ethylene glycol; some use tri-ethylene glycol. For ethylene glycol/water mixtures, we used the density and heat capacity for ethylene glycol mixtures from literature (5). For tri-ethylene glycol at the 60/40 ratio used in the industry we used the glycol package in HYSYS to generate the  $C_p$  and density at different temperatures (6).

### Water and Steam Properties

Water and steam properties were taken from literature references (7). Steam enthalpy is for saturated steam from steam tables (8).

*This document, and the opinions, analysis, evaluations, or recommendations contained herein are for the sole use and benefit of the contracting parties. There are no intended third party beneficiaries, and Jacobs Consultancy shall have no liability whatsoever to third parties for any defect, deficiency, error, omission in any statement contained in or in any way related to this document or the services provided.*

## Calculation of Emulsion Properties

Most participant sites provided volumetric flow rates, densities, and temperatures for emulsion, diluent, and dilbit. We estimated the densities, heat capacities and mass flows for dilbit and emulsion at flowing/standard temperatures using the correlations for heat capacity and density for the individual components (bitumen, diluent, and water) discussed above together with the proportion of bitumen and diluent in dilbit and the proportion of water and bitumen in the emulsion. The densities for the mixtures at temperature were used to convert volumetric flow to mass flow, which was used to estimate energy in the stream. Mass flow was also used in the estimation of the mass balance.

The estimation of emulsion mass flow and heat capacity involved several calculation steps. We used the linear correlation for Athabasca bitumen density vs. temperature discussed above. The intercept was adjusted as needed to match the site bitumen density.

1. Reference Athabasca Bitumen  $\rho = -0.83 \cdot T^{\circ}\text{C} + 1028 \text{ kg/m}^3$  (Athabasca Bitumen)
2. Bitumen at Site  $\rho = -0.83 \cdot T^{\circ}\text{C} + X \text{ kg/m}^3$  (site Bitumen) where X was determined from bitumen density at the temperature provided by the site

Next, we estimated the volume of water in the emulsion, which was not necessarily the same as the steam rate from the steam-to-oil ratio. We calculated the reservoir water retention rate as follows:

3. Water Retention Rate = Make-up Water – Disposal Water
4. Emulsion composition = (Steam – Water Retention) + Bitumen Production

Finally, we calculated the site-specific emulsion density ( $\rho$  Emulsion) at flowing conditions based on the site's bitumen density and water density at flowing conditions:

5.  $\rho \text{ Emulsion} = \rho \text{ water} * \text{vol\% water} + \rho \text{ Bitumen, site} * \text{vol\% Bitumen}$

We calculated the heat capacity ( $C_p$ ) of the emulsion based on the volume of water and bitumen in the mixture and the literature value for water  $C_p$  at flowing temperature and the value for bitumen  $C_p$  at flowing temperature determined using the Simple Method discussed above. The heat capacity for dilbit was calculated from the volume of diluent and bitumen in the mixture and the heat capacity for bitumen and for diluent calculated using the Simple Method.

## Glycol Losses

Energy loss in the glycol system includes both losses to the glycol air coolers (at all Study sites) and to the glycol heaters (at some Study sites). Glycol air cooler losses were calculated by multiplying the difference between the glycol cooler inlet and outlet temperatures by the glycol flow rate and heat capacity at temperature.

Glycol heater losses were defined as the heat lost to the flue gas in the glycol heaters, since heater duty absorbed by the glycol is either transferred to process fluids or lost to the glycol air coolers. The rate of natural gas consumed in the glycol heaters was provided by the sites that used glycol heaters. Glycol heater stack losses were estimated based on data provided or by assuming a glycol heater efficiency.

Because of the way CSS plants are designed and operated, they require a much smaller glycol system than SAGD plants. As a result of the differences in glycol systems, data points for glycol loss for CSS can be distinguished from data points for SAGD. To preserve data anonymity we will not show CSS data points but will include this data in calculating average glycol loss for all sites.

## OTSG Efficiency and Stack Losses

Stack loss is the heat left in the OTSG flue gas that is not recovered by heat exchange with fuel, air, or BFW. In most cases, OTSG stack losses were calculated for the Study based on the Tammo equation, which is derived from correlation of absorbed duty vs. fired duty for heaters. This correlation includes radiation loss and is as follows:

1. OTSG efficiency is calculated using the following equation and provided data:

$$e = \frac{97.5 - 0.034 * T + 0.26 * O_2 - 0.00001 * T^2 - 0.0025 * T * O_2 - 0.00416 * O_2^3}{100}$$

Where e = OTSG efficiency, T = Stack Temperature in °C, and O<sub>2</sub> = Flue Gas % O<sub>2</sub>.

2. Absorbed duty is calculated using the following equation, which depends on fired duty, which is provided, and OTSG efficiency (e), which is calculated using the previous equation.

$$\text{Absorbed Duty} = \text{Fired Duty} * e$$



3. Stack losses are calculated as follows:

$$\text{Stack Loss} = \text{Fired Duty} - \text{Absorbed Duty}$$

Thus, stack losses are affected primarily by two factors: absorbed duty (which is primarily a function of BFW temperature at the boiler inlet) and efficiency (which is primarily a function of excess oxygen and flue gas temperature).

Note: Efficiencies are calculated differently for heat recovery steam generators (HRSGs) in cogeneration plants than for OTSGs. Also, electricity losses in plants using grid-based power are different than electricity losses from plants using cogen. For sites that cogenerate steam and electricity we used the industry convention that the steam from cogen is generated at 100% efficiency, which means that the losses are attributed to electricity generation. Therefore, we combined the losses from the OTSG stacks and from electricity to enable comparison of losses from steam generation and electricity between sites with and without cogen, which helped preserve data confidentiality.

## Electricity Consumption and Losses

Electricity consumption rates were provided by each site. For sites using electric submersible pumps (ESPs), electricity consumption (given or estimated) by the ESPs was subtracted from site electricity consumption because ESPs were not considered part of the CPF.

### Alberta Electricity Grid

We used information from the Alberta Electricity System Operator (AESO), shown in Figure 3.4, for electricity generation in Alberta for 2013 to estimate the heat rate and GHG intensity for Alberta's grid-based electricity supply (9).

**Figure 3.4**  
**Energy Production in Alberta by Asset Type (2013**  
**Annual Market Statistics, AESO – Figure 13)**



The proportion of electricity generation for 2013 from Figure 3.4 is used in Table 3.3. We used an Alberta grid line loss of 4%, which is reported by AESO (11). The heat rate/efficiency for grid electricity production from various sources in Alberta is on the basis of higher heating value (HHV) (12). Biomass heating values are from NREL (13). We converted HHV heating rates to LHV using the ratio of LHV to HHV for each of the fuels used (14). The grid efficiency on a LHV basis is 49% with a heat rate of 7.3 GJ/MWh. When line loss is included, the efficiency drops to 47.1% with a LHV heat rate of 7.65 GJ/MWh (2.12 GJ of fuel/GJ of electricity generated). Finally we estimated the overall grid GHG emission factor of 763 kg CO<sub>2</sub>/MWh when line loss is included (15). The GHG emission factors for the sources of electricity on the Alberta grid are shown in Table 3.3.

*This document, and the opinions, analysis, evaluations, or recommendations contained herein are for the sole use and benefit of the contracting parties. There are no intended third party beneficiaries, and Jacobs Consultancy shall have no liability whatsoever to third parties for any defect, deficiency, error, omission in any statement contained in or in any way related to this document or the services provided.*

**Table 3.3  
Electricity Production in Alberta**

	2013 Gen Share	Alberta Line Loss	Heat Rate (HHV)	Efficiency HHV	Heat Rate (LHV)	Efficiency LHV	GHG Intensity of Source	Heat Rate/Efficiency Source
	%	%	GJ/MWh	%	GJ/MWh	%	kg CO2/MWh	
Coal	63		9.5	37.9	9.0	40.0	1,000	AESO Efficiency
Cogen	17		5.0	72.0	4.5	79.8	250	AESO Efficiency
Gas <sup>1</sup>	5		6.5	55.4	5.9	61.4	420	AESO Efficiency
Peaker <sup>2</sup>	2		10.3	35.0	9.3	38.8	480	Ontario Power Efficiency
Hydro	2		0				0	
Wind	6		0				0	
Other <sup>3</sup>	1		13.2	27.3	12.3	29.2	0	NREL
Imports <sup>4</sup>	4		7.8	46.1	7.3	49.0	732	Weighted average of above
Total	100		7.8	46.1	7.3	49.0	732	
Line Loss		4						From AESO - Final_Alberta_Loss_Factors_for_2011.pdf <a href="http://www.aeso.ca/downloads/Final_Alberta_Loss_Factors_for_2011.pdf">http://www.aeso.ca/downloads/Final_Alberta_Loss_Factors_for_2011.pdf</a>
Net with Line Loss						47.1	763	

Fuel GJ / Electricity Generated GJ	2.12
Heat Rate, GJ/MWh	7.65
Carbon Intensity of Grid, kgCO2e/MWh	763

1. Assume Gas is combined cycle
2. Assume Peaker is simple cycle
3. Heat rate for Other is an average heat rate from NREL for biomass
4. Heat rate for Import is the weighted average of coal, cogen, peaker, hydro, wind and other gen sources

Electricity losses are defined as the difference between the energy in the fuel used to generate the electricity and the energy in the electricity consumed by the site (whether produced onsite or imported from the grid).

### Cogeneration Efficiency Definition

Since the relative rates of fuel gas to the gas turbine vs. fuel gas to the HRSG were not available for each cogeneration site, we followed the industry standard of combining all aspects of cogeneration into a single heat rate:

$$\text{Heat Rate} = \frac{\text{Fuel Gas}_{\text{Cogen}} - \text{Flow}_{\text{Steam}} * \Delta H_{\text{Steam}}}{\text{Electricity Generated}_{\text{Cogen}}}$$

When all terms are in the same units, e.g. GJ, the heat rate is the inverse of the cogen efficiency. For a cogeneration site, the steam generation and electricity generation are considered together. The industry convention is to assume that all losses in cogen are attributed to electricity generation. Thus steam from cogeneration is generated at 100% efficiency. Exported electricity produced onsite and the fuel and losses associated with its production are not included in the site metrics. Thus, the fuel used to generate the exported electricity must be subtracted from the fuel consumed on site.

There are differences in losses from electricity generation for grid-based electricity vs. cogenerated electricity and for the efficiency of steam generation in an OTSG and a HRSG. Therefore, when comparing losses between sites it is necessary to add stack losses and electricity losses and not treat them separately.

## Cogeneration Gas Rate Calculation

The total rate of fuel gas to the cogeneration unit (HRSG + gas turbine) was provided in some cases and calculated in other cases. Where it was not provided, we estimated the fuel gas rate by performing a gas balance on the entire site and assigning unaccounted-for natural gas to fuel used in cogen.

$$\begin{aligned} & \text{Imported natural gas (LHV)} \\ & + \text{Produced gas (LHV)} \\ & + \text{Syngas (LHV) (if applicable)} \\ & - \text{OTSG Fired Duties} \\ & - \text{Glycol Heater Fired Duties (if applicable)} \\ & = \text{Cogen Fuel (LHV)} \end{aligned}$$

## Gaps in Mass and Energy Balances

The initial mass and energy balances gave some indication as to the accuracy of our assumptions and calculation factors. We used these balances as a means to fine-tune some of the factors used and to filter outlying data. As discussed, we developed temperature-dependent correlations for bitumen, water, and diluent (and thus also for emulsion and dilbit). We filtered out data points that were outside 100%  $\pm$ 10% for mass balance and 100%  $\pm$ 35% for energy balance. With these methods of fine-tuning, the balances improved, but there was still an energy gap, which we call Energy to Balance. This term may include some minor energy losses not accounted for, such as losses through insulation or to air. However, because some sites had a negative Energy to Balance, we find this term to be an unreliable metric in the evaluation of a site's energy consumption because it is likely to include measurement errors/uncertainties.

Further, calculation of the mass and energy balances depends on large flow rates and estimated properties. For example, the emulsion density and heat capacity depend on the emulsion composition, which is determined by the water balance and on the heat capacity and density of bitumen, which are estimated from correlations. A small change in any of these properties has a big impact on the overall emulsion energy content, which is the process stream with the largest rate of energy into the plant. A similar uncertainty applies to estimating the energy in the dilbit stream.

Because of uncertainty in closing the energy and mass balances, we decided to focus on developing metrics that were both measurable/calculable with reasonable accuracy. These higher-confidence parameters include the steam rate out of the CPF; the gas and electricity consumption in the CPF; and losses to the glycol system, stacks, and electricity generation.

## Gas Properties

We used the properties of natural gas and produced/associated gas provided by the study participants. When this information was not available, we used typical composition and component properties for these gases shown in Table 3.4.

**Table 3.4**  
**Gas Composition and Component Properties for Typical Gas Streams**

	Properties				Natural Gas	Produced Gas
	Molecular Weight	Net Heat of Combustion (LHV)	CO <sub>2</sub>	Carbon Intensity (LHV)	Mole Fraction	Mole Fraction
	g/mole	MJ/kg	g CO <sub>2</sub> /g Molecule	g CO <sub>2</sub> /MJ	Mole%	Mole%
H <sub>2</sub> O	18.02	---	---	---	---	3.9%
H <sub>2</sub>	2.02	119.62	---	---	---	0.2%
CO	28.01	10.11	1.57	155.4	---	---
CO <sub>2</sub>	44.01	---	1.00	---	0.1%	29.1%
O <sub>2</sub>	32.00	---	---	---	---	---
N <sub>2</sub>	28.01	---	---	---	1.3%	1.0%
NH <sub>3</sub>	17.03	16.64	---	---	---	---
H <sub>2</sub> S	64.08	15.20	---	---	---	0.1%
C <sub>1</sub>	16.04	50.03	2.74	54.8	95.8%	56.7%
C <sub>2</sub>	30.07	47.51	2.93	61.6	2.5%	1.4%
C <sub>3</sub>	44.10	46.33	2.99	64.6	0.2%	1.7%
iC <sub>4</sub>	58.12	45.57	3.03	66.5	---	0.2%
nC <sub>4</sub>	58.12	45.72	3.03	66.2	---	---
iC <sub>5</sub>	72.15	44.89	3.05	67.9	---	---
nC <sub>5</sub>	72.15	44.97	3.05	67.8	---	---
C <sub>6</sub> +	100.20	44.44	3.07	69.2	---	5.6%
Total					100.0%	100.0%

Table 3.5 shows the overall properties of typical natural gas and produced gas based on the values from Table 3.4.

**Table 3.5**  
**Properties for Typical Natural Gas and Produced Gas**

	Molecular Weight	Net Heat of Combustion (LHV)	CO <sub>2</sub>	Carbon Intensity (LHV)
	g/mole	MJ/kg	g CO <sub>2</sub> /g Fuel	g CO <sub>2</sub> /MJ
Natural gas	16.68	48.62	2.69	55.3
Produced gas	29.86	25.65	1.97	76.8

## GHG Factors

We used GHG emission factors for each primary emissions source based on published values and from our previous studies. The GHG intensity of syngas is high because of its high CO content and low heating value. We found in developing GHG metrics that including data points for sites using syngas risked exposing the source of data. To get around this problem, we used the GHG intensity of natural gas in place of the GHG intensity of syngas to enable inclusion of data from sites using syngas in the estimate of average GHG emissions from all sites.

**Table 3.6**  
**GHG Emissions Factors Used**

Energy Type	GHG Intensity	Source of Information
Alberta Grid Electricity Production GHG	0.763 kg CO <sub>2</sub> e/kWh	Calculated from 2013 AESO data (see previous)
Produced Gas Boiler GHG	76.8 kg CO <sub>2</sub> e/GJ LHV	Jacobs Consultancy – typical produced gas properties
Natural Gas Boiler GHG	55.3 kg CO <sub>2</sub> e/GJ LHV	GREET data
Natural Gas to Overall Cogen GHG	55.5 kg CO <sub>2</sub> e/GJ LHV	GREET data
Syngas Boiler GHG	128.7 kg CO <sub>2</sub> e/GJ LHV	Jacobs Consultancy previous study

## Calculations

Each data point that met the filtering criteria as defined above was weighted equally in the overall metrics; some sites supplied fewer points. We compared the individual metrics for a site to the overall metrics by comparing the average of all filtered data from a site to the overall average from all the filtered data points from all sites as well as the filtered average  $\pm$  one standard deviation.

## Potential In Situ Benchmarking Metrics

The metrics can be calculated in three different ways; per  $m^3$ /barrel of bitumen, per  $m^3$  of steam, and per GJ of steam. *Per  $m^3$ /barrel of bitumen* is interesting when focusing on energy intensity of bitumen production, but this basis is heavily affected by SOR, thus there is concern about data anonymity. *Per  $m^3$  of steam* is tangibly meaningful, but does not take into account differences between steam qualities within or between sites (steam temperature, pressure, or water content—wet/dry steam). Thus, we chose to compare results on the basis of *GJ of steam* because it minimizes the effects of different reservoir steam requirements and steam properties.

As used in this Study, a GJ of steam is the amount of saturated steam whose steam-table enthalpy is equal to 1 GJ. For example, 1 GJ of 10,000 kPa saturated steam is about 370 kg of steam. The average duty absorbed in all steam generators across all sites was about 0.84 GJ/GJ of steam (the actual fired duty LHV would be greater).

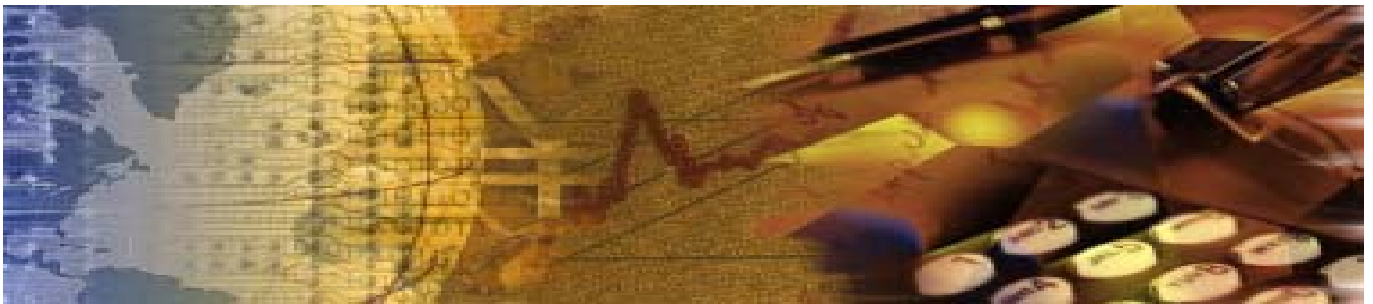
The metrics we focused on for the Study include the impact of various operating parameters: BFW temperature, emulsion temperature, SOR, and turndown from maximum operations. The metrics also include losses/efficiency as well as energy consumption and GHG emissions. We also looked at energy losses to the stacks and electricity generation and losses to the glycol system per GJ of steam.

Energy consumption as defined for this Study includes all gas consumed in the CPF, including natural gas, syngas, and produced gas, as well as electricity consumed in the CPF as fuel equivalents as previously defined, subtracting the fuel used to generate electricity on site that is exported and to generate electricity used to drive ESPs and other equipment not in the boundary for the CPF used in the Study.

—This page intentionally blank—



## Section 4.



## Results

In this section we examine a number of potential benchmarking metrics. In addition, we will look at the relationships between a number of key metrics and key CPF operating parameters to identify those with greatest impact.

We evaluated the following as potential benchmarking metrics:

- Mass balance
- Energy balance
- OTSG efficiency
- Energy consumption
- Electricity consumption
- Overall losses
- OTSG stack + electricity losses
- Glycol losses
- GHG emissions per GJ of steam
- Normalized GHG emissions per bbl of bitumen at 3.0 SOR

We also evaluated possible relationships between the following key benchmarking metrics and operating parameters:

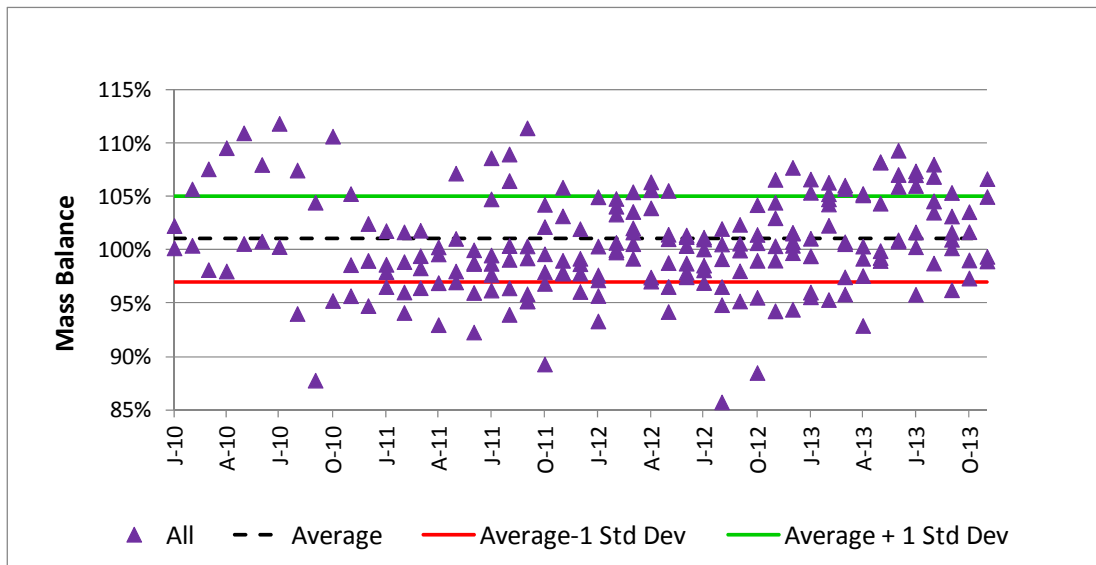
- Key metrics vs. steam rate
- Energy consumption vs. BFW temperature
- OTSG absorbed duty vs. OTSG BFW temperature
- Energy consumption vs. emulsion temperature
- Energy consumption vs. overall losses
- Glycol losses vs. glycol air cooler inlet temperature
- OTSG stack losses vs. OTSG stack temperature
- OTSG stack temperature vs. OTSG BFW temperature
- Effect on the GHG emissions on average from using either 100% electricity that is cogenerated with steam or 100% from the Alberta grid
- Effect of OTSG efficiency on the GHG emissions on average

- Correlation of GHG emissions and glycol losses
- Correlation of GHG emissions and total steam generation absorbed duty
- Correlation of GHG emissions and OTSG stack losses
- Relative impact on GHG emissions from varying glycol losses, absorbed duty, and OTSG stack losses  $\pm$  one standard deviation of the average value

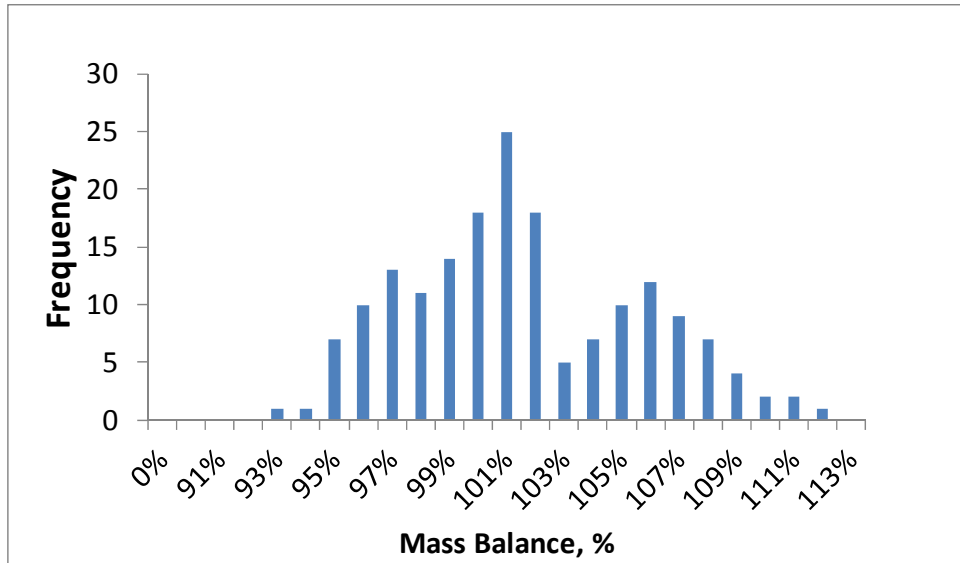
## Mass Balance

There is good closure of the mass balance around the CPF for all data from all sites. The streams in and out of the CPF are identified in Table 3.1. The mass balance  $\pm$  one standard deviation is centered between 97 and 105% shown in Figure 4.1 as red and green lines. The histogram of mass balance data points for all sites shown in Figure 4.2 is centered around 100-103% based on  $\text{Mass}_{\text{out}}/\text{Mass}_{\text{in}}$ .

**Figure 4.1**  
**Mass Balance—All Sites**



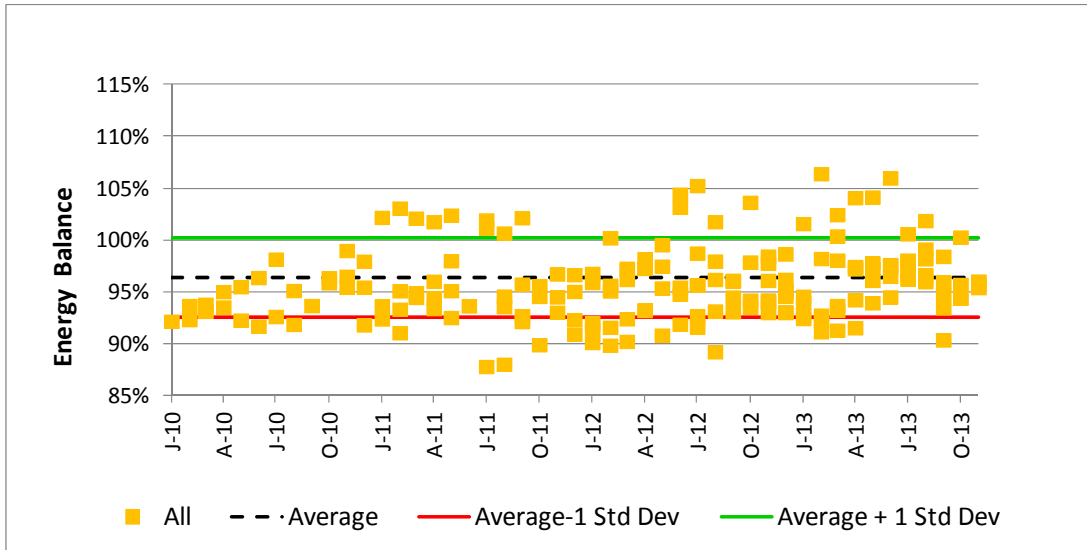
**Figure 4.2**  
**Mass Balance Histogram—All Sites**



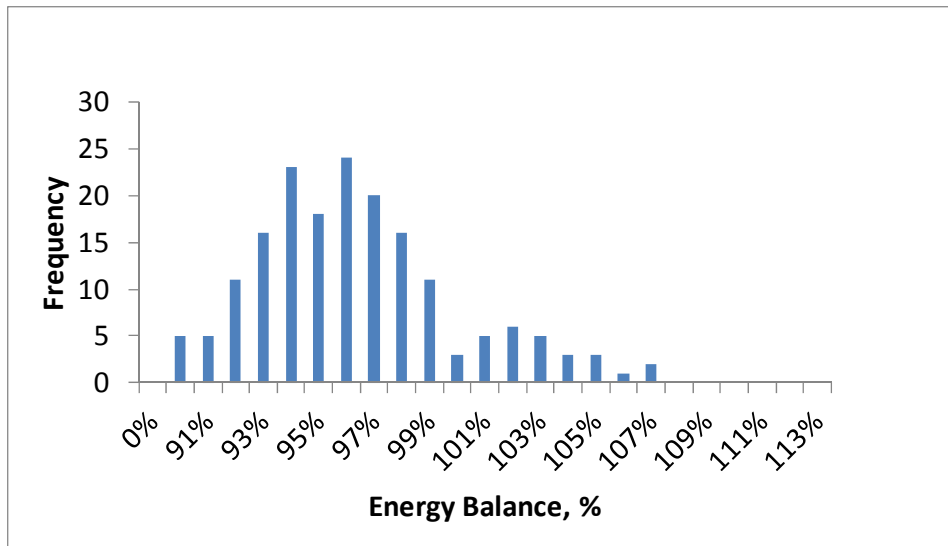
## Energy Balance

There is fairly good closure of the energy balance around the CPF for all data from all sites as shown in Figure 4.3. The sources of energy in and out of the CPF and the losses are identified in Table 3.2. The energy balance  $\pm$  one standard deviation is centered between 92 and 100% by the red and green lines in Figure 4.3. The histogram of energy balance data points for all sites is shown in Figure 4.4. and is centered around 95-98% based on  $\text{Energy}_{\text{out}}/\text{Energy}_{\text{in}}$ .

**Figure 4.3**  
Energy Balance—All Sites



**Figure 4.4**  
Energy Balance Histogram—All Sites

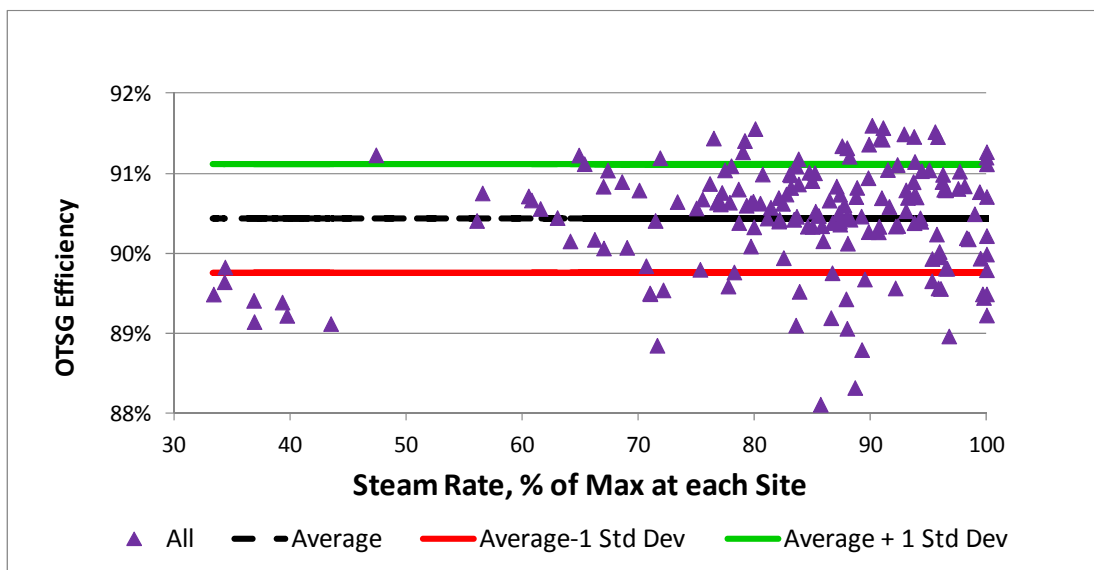


*This document, and the opinions, analysis, evaluations, or recommendations contained herein are for the sole use and benefit of the contracting parties. There are no intended third party beneficiaries, and Jacobs Consultancy shall have no liability whatsoever to third parties for any defect, deficiency, error, omission in any statement contained in or in any way related to this document or the services provided.*

# OTSG Efficiency

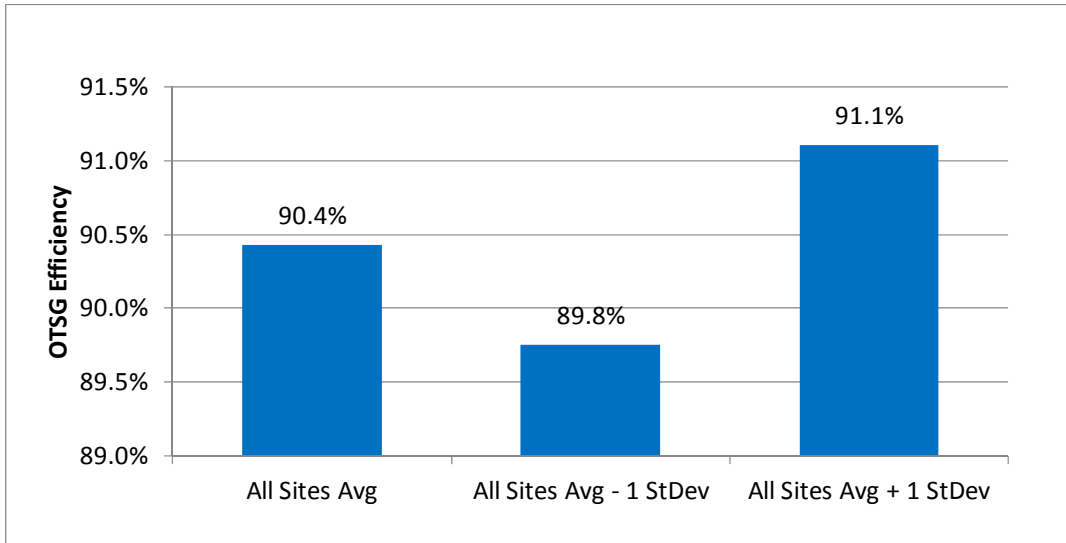
OTSG efficiency shown in Figure 4.5 seems to be independent of steam rate. The average OTSG efficiency is 90.4% (LHV basis) with a standard deviation of 0.7%, which is 0.7% of the average. The percent of maximum steam rate shown is calculated for each site based on the highest steam rate at that site based on filtered data. A histogram of the OTSG efficiency data points, plotted in Figure 4.7, is centered between 90.6 and 91%. These results imply efficient management of steam generation for all sites.

**Figure 4.5**  
**OTSG Efficiency vs. Steam Rate—All Sites**

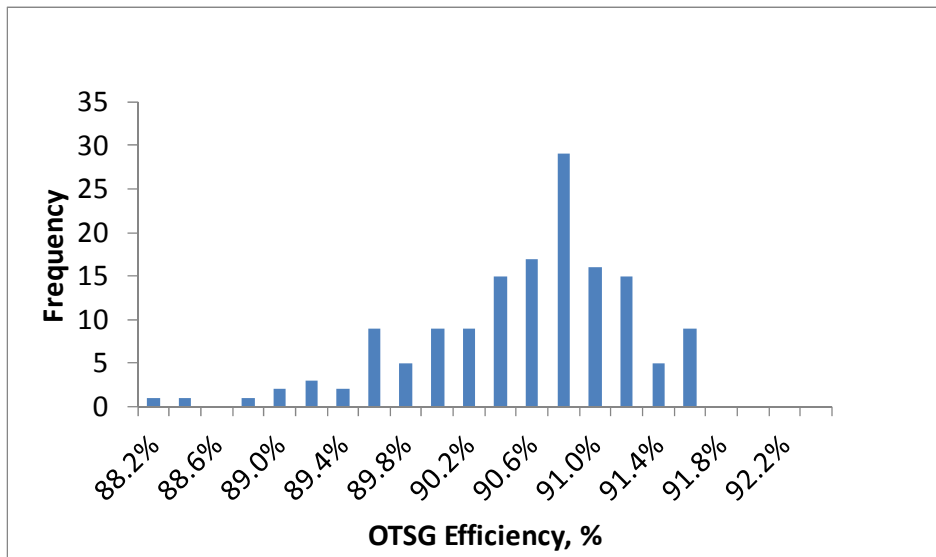


*This document, and the opinions, analysis, evaluations, or recommendations contained herein are for the sole use and benefit of the contracting parties. There are no intended third party beneficiaries, and Jacobs Consultancy shall have no liability whatsoever to third parties for any defect, deficiency, error, omission in any statement contained in or in any way related to this document or the services provided.*

**Figure 4.6**  
**OTSG Efficiency—Overall—All Sites**



**Figure 4.7**  
**OTSG Efficiency Histogram—All Sites**



# Energy Consumption

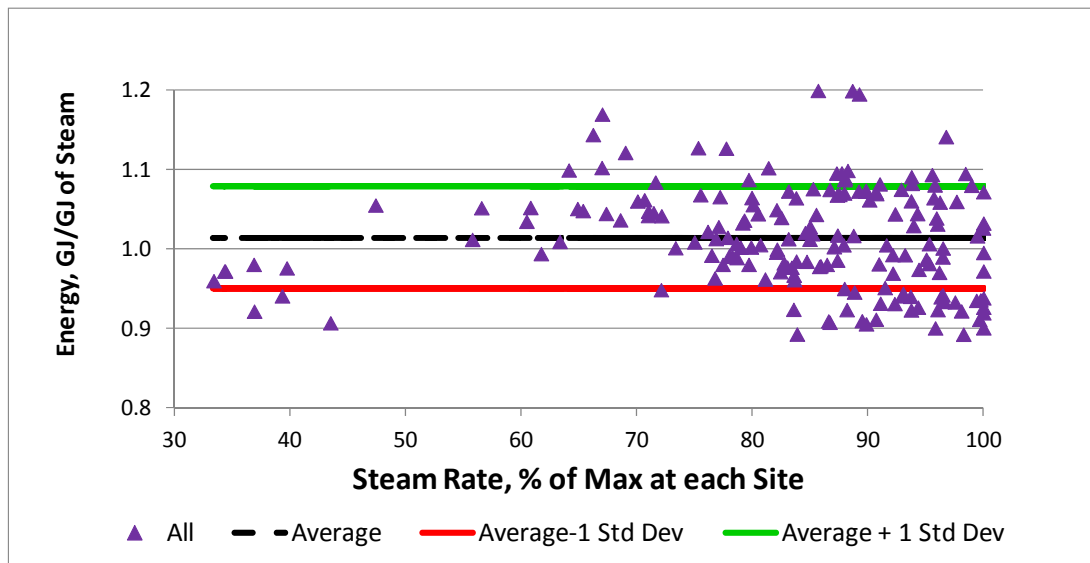
Energy consumption as defined for this Study includes all gas consumed in the CPF, including natural gas, syngas, and produced gas. It also includes all electricity consumed in the CPF, expressed as fuel required to generate electricity; it does not include fuel for onsite generation of exported electricity or fuel to generate electricity to drive ESPs or other equipment not in the CPF.

## Energy Consumption per GJ of Steam

In our analysis, a GJ of steam is defined as the energy content of all steam going to the well pad, based on saturated steam-table enthalpy. This means that steam characteristics such as temperature, pressure, and water content are not material to this metric.

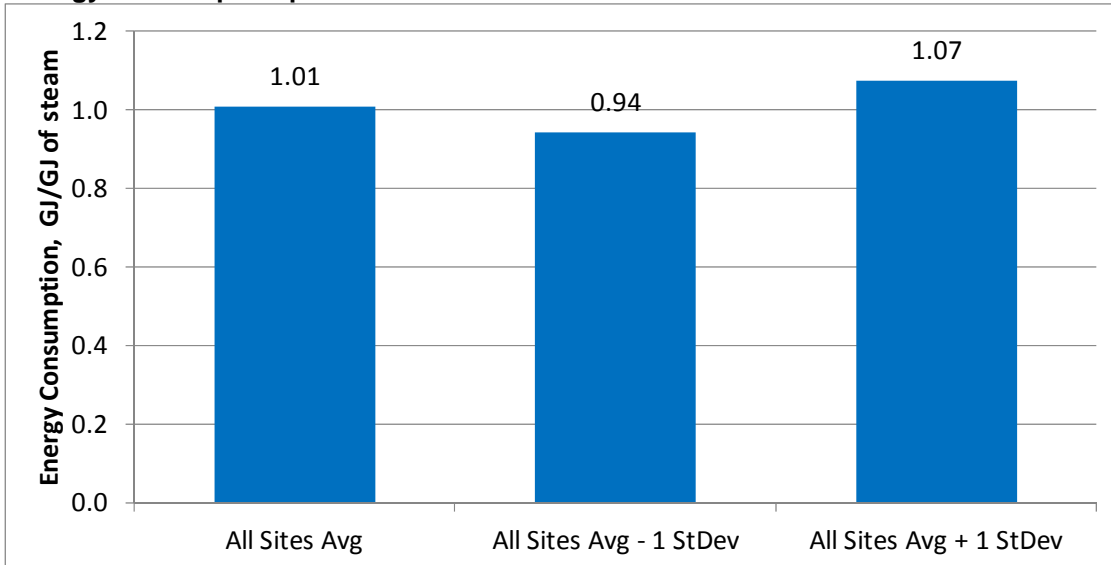
As with OTSG efficiency, the energy to generate steam is not affected by steam rate, again implying efficient management of steam generation. The average energy consumption across the data for all sites is 1.01 GJ on an LHV basis per GJ of steam (Figures 4.8 and 4.9). The standard deviation is 0.07 GJ/GJ of steam, which is 7% of the average. The energy consumption histogram in Figure 4.10 is centered on 1.01 GJ/GJ of steam.

**Figure 4.8**  
**Energy Consumed per GJ of Steam vs. Steam Rate—All Sites**

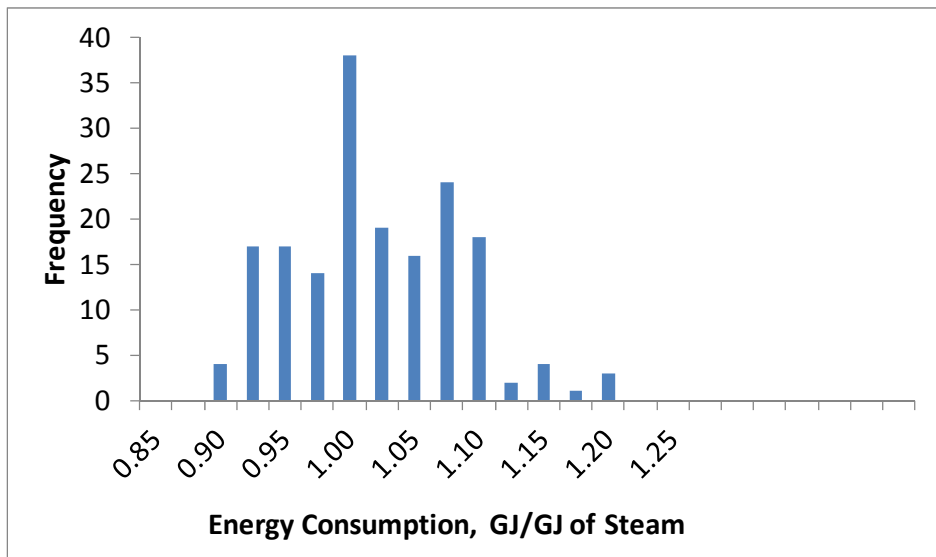




**Figure 4.9**  
**Energy Consumption per GJ of Steam—All Sites**



**Figure 4.10**  
**Energy Consumption Histogram—All Sites**



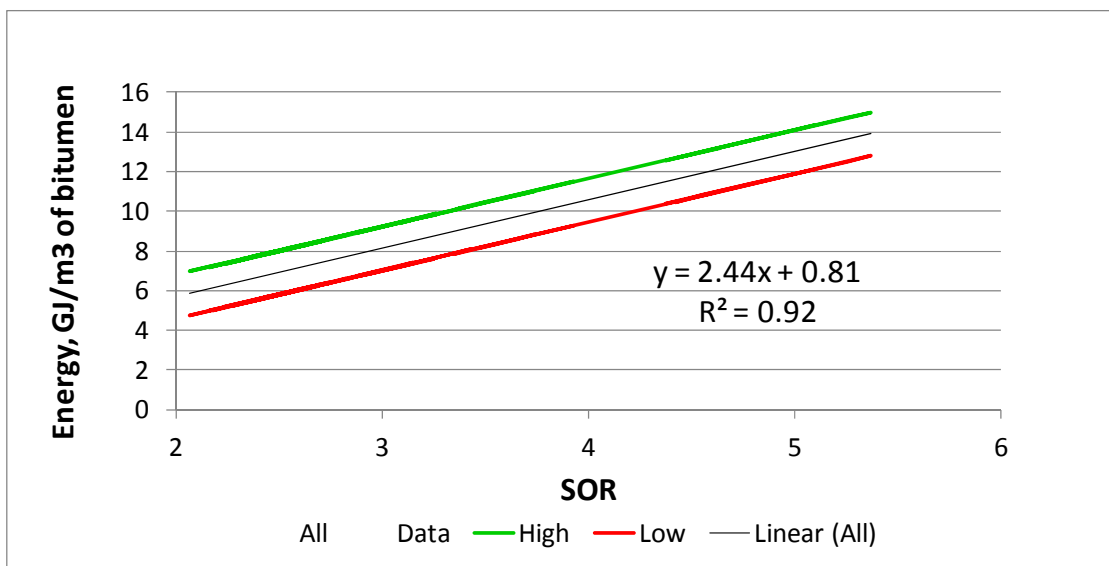
## Energy Consumption per m<sup>3</sup> of Bitumen

Energy consumption in the CPF is a strong function of SOR, which is highly dependent on the reservoir but may also be dependent on the design of the CPF. We were therefore curious to see if there were major differences between sites for energy consumption per m<sup>3</sup> of bitumen vs.

SOR. For this analysis our focus was on SAGD facilities because the steam quality and SOR are on a different basis in CSS facilities than in SAGD facilities.

Figure 4.11 shows a trend line fitting all SAGD data points for Energy Consumed per m<sup>3</sup> of Bitumen vs. SOR. Individual data points are not shown because they would reveal too much proprietary information about a site and data anonymity would be lost. The line shows a strong correlation between energy consumption per m<sup>3</sup> of bitumen and SOR over 6 SAGD sites with a correlation coefficient (R<sup>2</sup>) of 0.92, which indicates that steam production is the primary driver of energy consumption. However, absorbed duty and other energy consumption sources, such as electricity, vary between sites. In Figure 4.11 the red and green lines are the upper and lower bounds for all the data points for the SAGD sites; they do not represent ± one standard deviation from the average.

**Figure 4.11**  
**Energy Consumed per m<sup>3</sup> of Bitumen—SAGD Only**



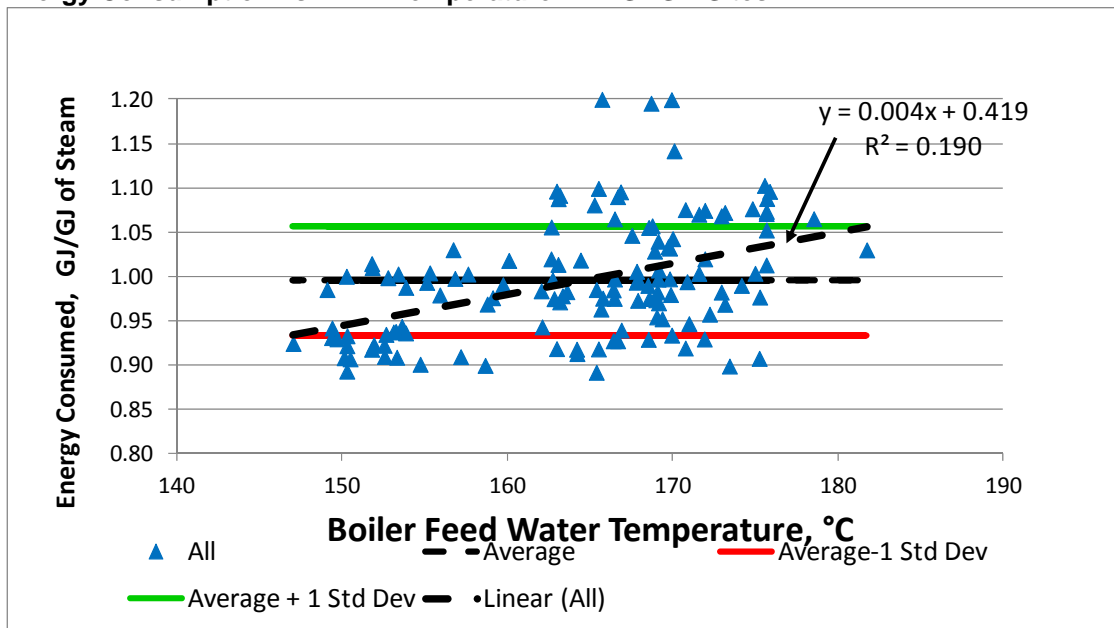
## BFW Temperature

BFW temperature was expected to have an impact on energy consumption to make steam. Higher BFW temperature was expected to result in less energy needed to generate steam. To make this comparison we focused on SAGD sites only. Data for CSS facilities were not included because differences in steam quality sent to the well pads and in the overall water balance result in BFW temperatures that are markedly different for CSS facilities than SAGD facilities.

As shown in Figure 4.12, energy consumption per GJ of steam shows a poor correlation with BFW temperature using the data from all the SAGD facilities and the correlation is in the opposite direction from what was expected. In addition, we saw little to no correlation when looking at the data for an individual site. The average value for energy consumed and  $\pm$  one standard deviation are included in the figure.

However, since energy consumption depends on a number of different factors, we looked more closely at the data to try to determine why the correlation was so poor. In design of commercial in situ bitumen production facilities, steam production has been shown to be the major factor in overall energy consumption and the design energy required for steam production depends directly on BFW temperature.

**Figure 4.12**  
**Energy Consumption vs. BFW Temperature—All SAGD Sites**

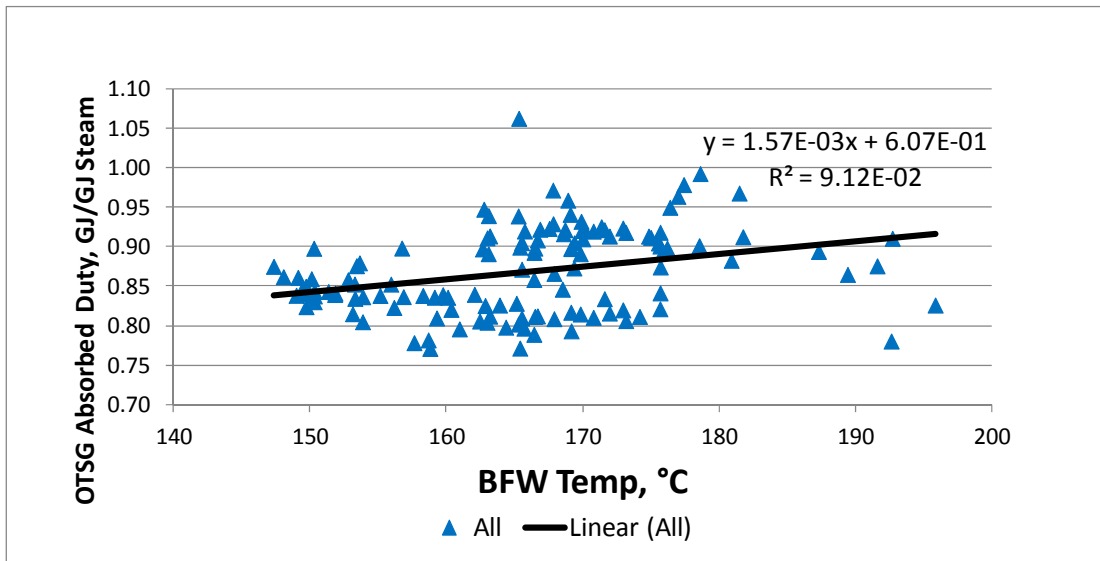


Within a single site, OTSG absorbed duty should closely correlate with OTSG BFW temperature, because the absorbed duty is based only on inlet (BFW) temperature, outlet (steam) temperature, and outlet steam quality (water content). Also, the steam temperatures and pressures/qualities at a site do not vary significantly. However, when we plotted OTSG Absorbed Duty vs. OTSG BFW Temperature for each site, some sites showed a direct correlation as expected, but most did not.

We suggest that the lack of correlation of BFW temperature with energy to produce steam indicates that the measurement of one or more parameters, likely including BFW temperature, is

not accurate enough for a correlation to be observed at most sites, and/or there is an inconsistency in the location of measurement. Figure 4.13, OTSG Absorbed Duty vs. OTSG BFW Temperature for all SAGD sites, shows a very poor correlation.

**Figure 4.13**  
**Absorbed Duty vs. BFW Temperature—All SAGD Sites**

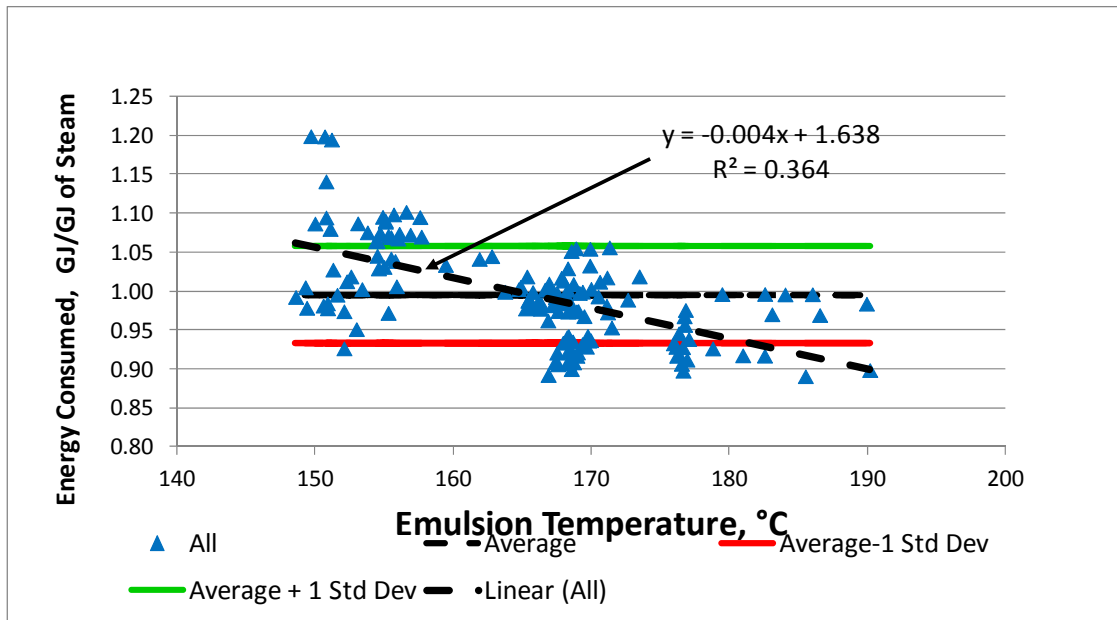


## Emulsion Temperature

As with BFW temperature, we expected that the energy to generate steam would decrease with increasing emulsion temperature. As shown in Figure 4.14, the correlation is weak. These results are for SAGD sites only. The average value for energy consumed and  $\pm$  one standard deviation are included in the figure.

The poor correlation may be due to metering inaccuracy and/or the indirect relationship between emulsion temperature and energy consumption. Higher emulsion temperature may lead to lower energy consumption, but only if the increased heat in the emulsion is recovered to the process via heat exchange with BFW or other process streams. Again, CSS is not included due to the differences in steam quality sent to the well pads and in the overall water balance, and because of the resulting differences in emulsion temperatures between CSS and SAGD facilities.

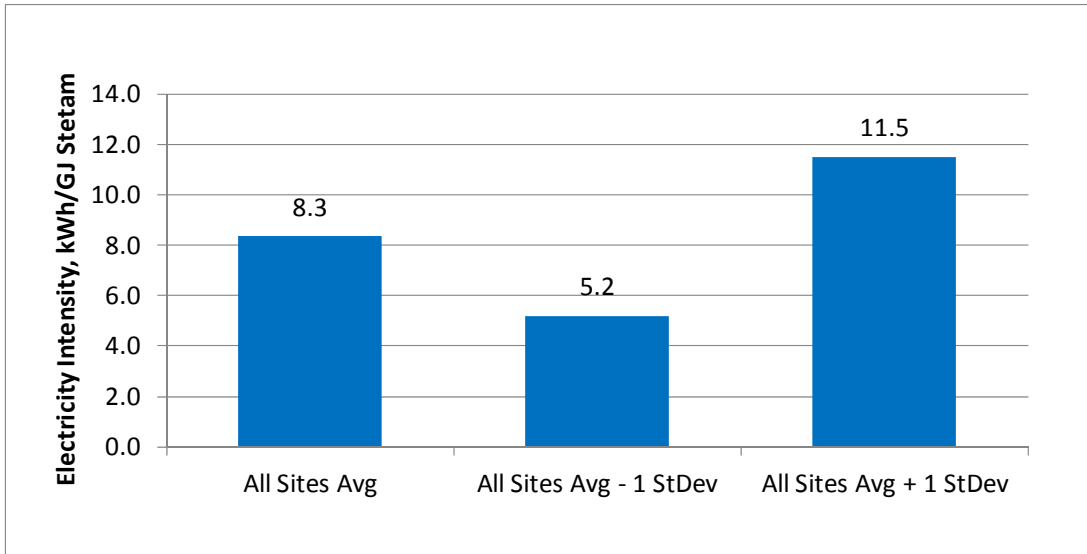
Figure 4.14  
Energy Consumed vs. Emulsion Temperature—All SAGD Sites



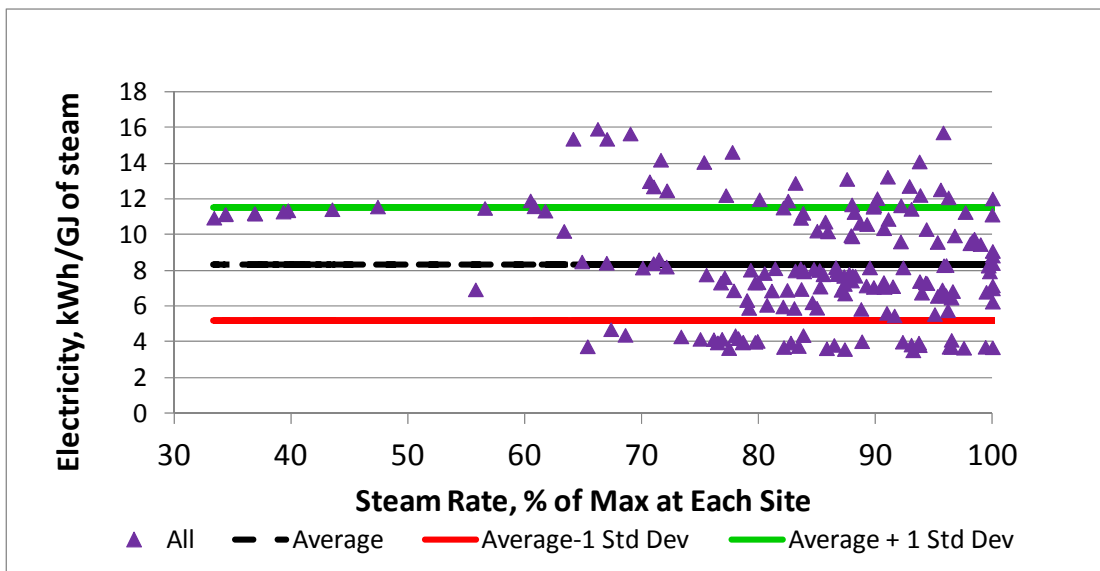
## Electricity Consumption

Figure 4.15 shows the average electricity consumption  $\pm$  one standard deviation for electricity consumption per GJ of steam; there is a significant difference in electricity consumption between sites. The average electricity consumption is 8.3 kWh/GJ of steam, with a standard deviation of 3.1 kWh/GJ of steam, which is 38% of the average. Figure 4.16 shows no significant variation in electricity consumption per GJ of steam with variation in capacity utilization.

**Figure 4.15**  
**Electricity Consumption per GJ of Steam—All Sites**



**Figure 4.16**  
**Electricity Consumption per GJ of Steam vs. Steam Rate—All Sites**



## Major Quantifiable Losses

As discussed in Section 3, during the course of the Study it became clear that our focus should be on determining quantifiable losses from the CPF, which include loss to the OTSG stacks, loss from electricity consumption, and loss to the glycol system. We also determined that the energy gap—between Energy In and Energy Out + Loss—which we called the Energy to Balance, was unreliable as a metric, and we dropped it from consideration.

### Overall

Figure 4.17 shows the average overall loss as 0.21 GJ/GJ of steam, with a standard deviation of 0.05 GJ/GJ of steam, which is 27% of the average. As shown in Figure 4.18, loss seems fairly independent of steam production rate. Figure 4.19 shows the histogram for average loss, which is centered on 0.22-0.24 GJ/GJ of steam. For most SAGD sites, the magnitude of glycol loss is approximately equal to the magnitude of stack + electricity loss.

**Figure 4.17**  
Losses per GJ of Steam—Overall—All Sites

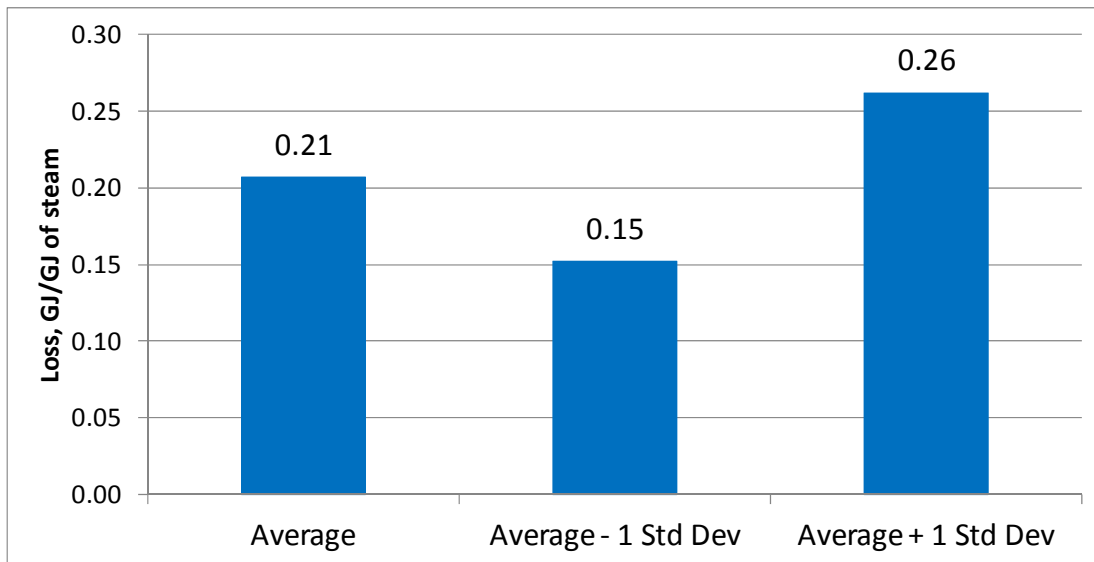


Figure 4.18  
Loss per GJ of Steam vs. Steam Rate—All Sites

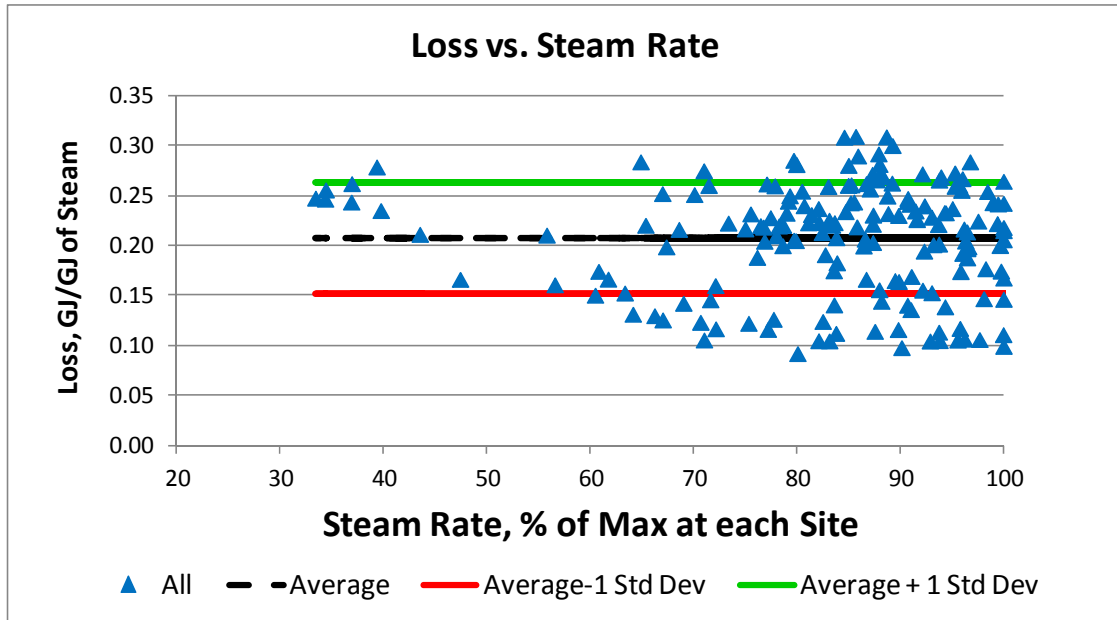
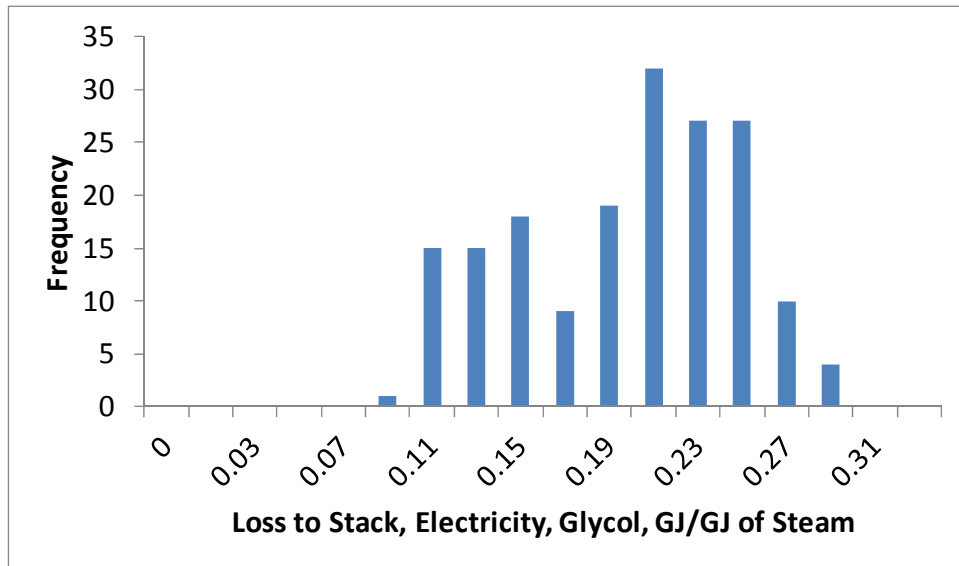


Figure 4.19  
Loss/GJ of Steam Histogram—All Sites

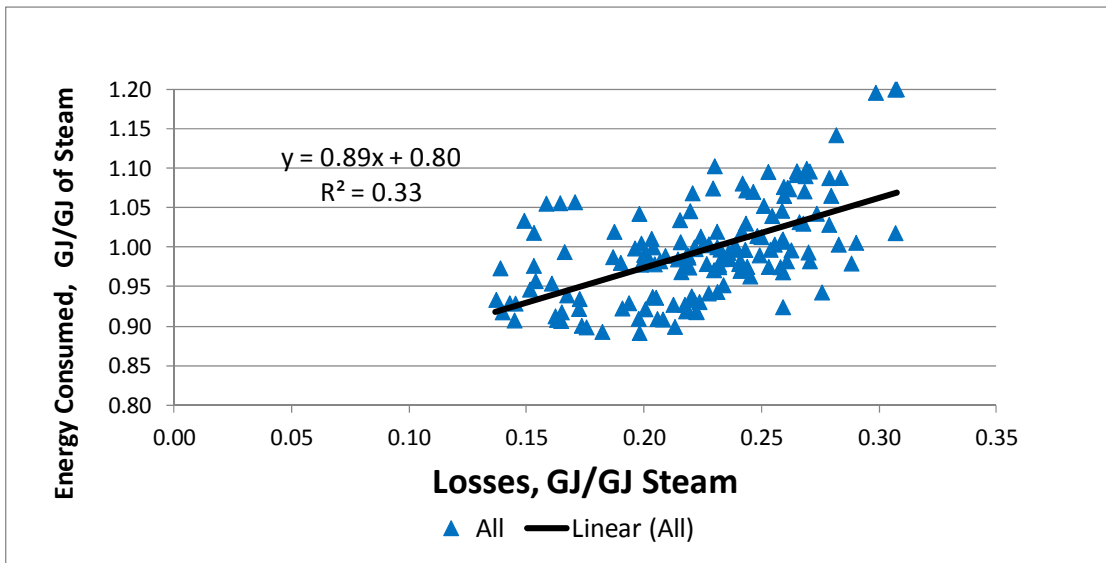


We looked at the relationship between energy consumption per GJ of steam and stack + electricity + glycol losses per GJ of steam. The data from individual sites show a general trend



of increasing energy consumption with increasing loss. However, as shown in Figure 4.20, there is significant scatter in the plot of energy consumed per GJ of steam vs. loss per GJ of steam. These results are for SAGD only because the relationship between energy consumption and loss for CSS facilities is different and data anonymity would be compromised if these data were included. For the SAGD sites energy consumption increases with overall loss but the correlation is weak.

**Figure 4.20**  
**Energy Consumption vs. Losses—SAGD Only**

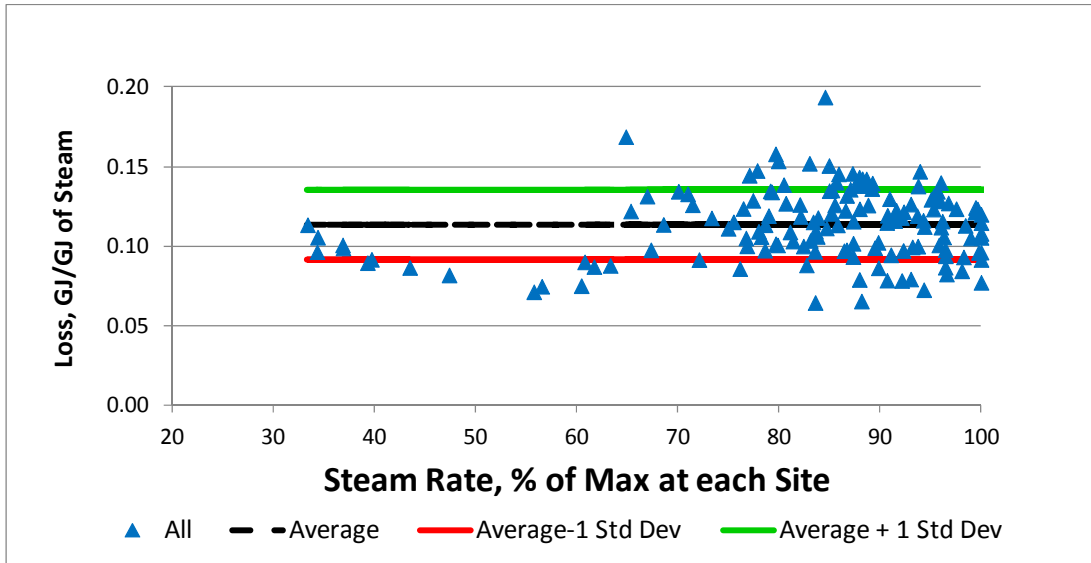


## Glycol Losses

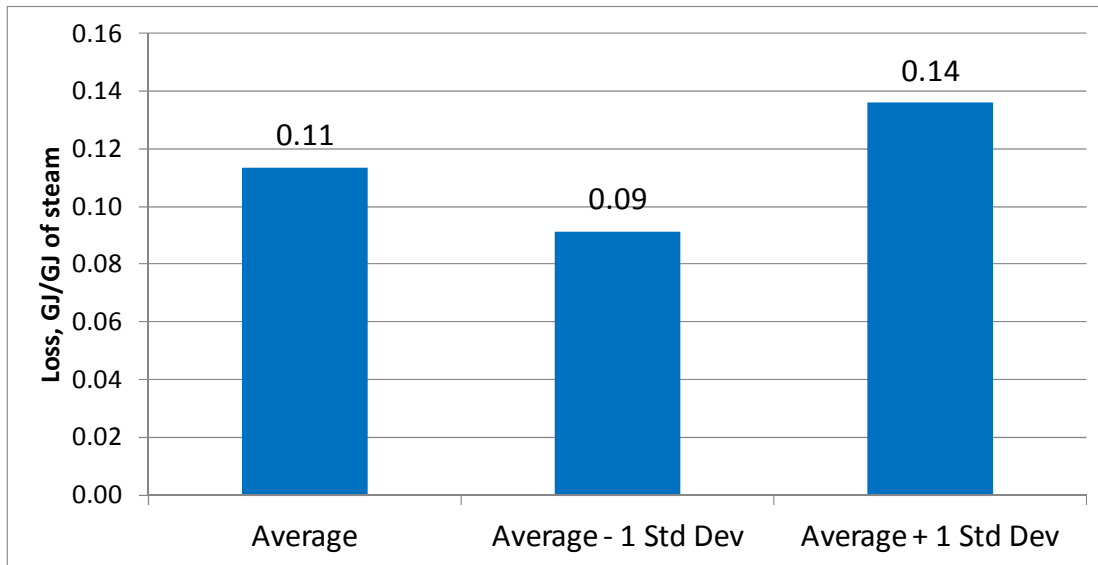
Thermal in situ bitumen production sites transfer low level heat between streams, often through glycol systems. In the case of CSS facilities much of the low level heat can be directly transferred to the water circulating through the reservoir, well pad and CPF, which is at a much greater rate than in SAGD facilities. As a result of being able to use the circulating water as a heat sink, the glycol systems in CSS facilities are much smaller than in SAGD facilities. We will not show any CSS data points with the SAGD data points to preserve data confidentiality but will include CSS data in determining the average loss to the glycol system from all sites.

Figure 4.21 shows glycol loss for all the SAGD sites. Figure 4.22 shows the average glycol losses per GJ of steam across all SAGD sites. The average glycol loss is 0.11 GJ/GJ of steam, and the standard deviation is 0.02 GJ/GJ of steam, which is 20% of the average. Figure 4.23 shows that the histogram for glycol loss from SAGD facilities is centered on 0.11-0.13 GJ/GJ of steam.

**Figure 4.21**  
Glycol Loss vs. Steam Rate—SAGD Only



**Figure 4.22**  
Glycol Loss—SAGD Only



**Figure 4.23**  
**Glycol Loss Histogram—SAGD Only**

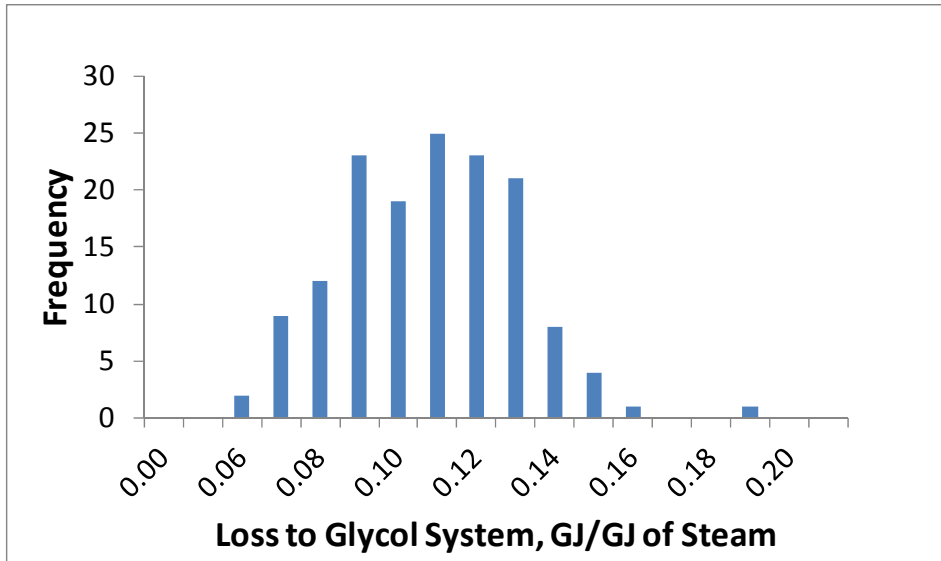
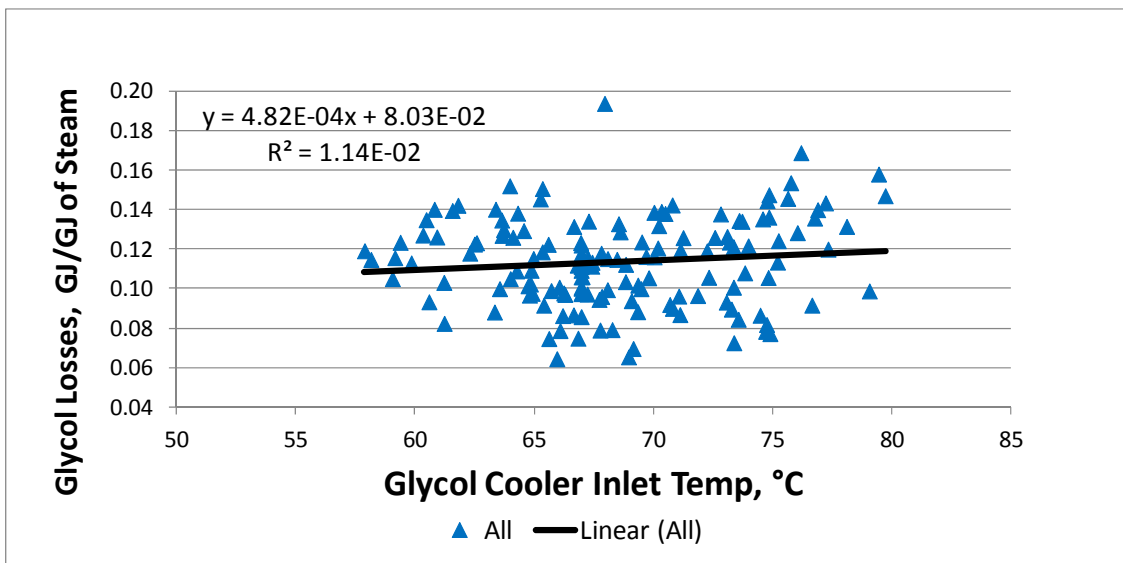


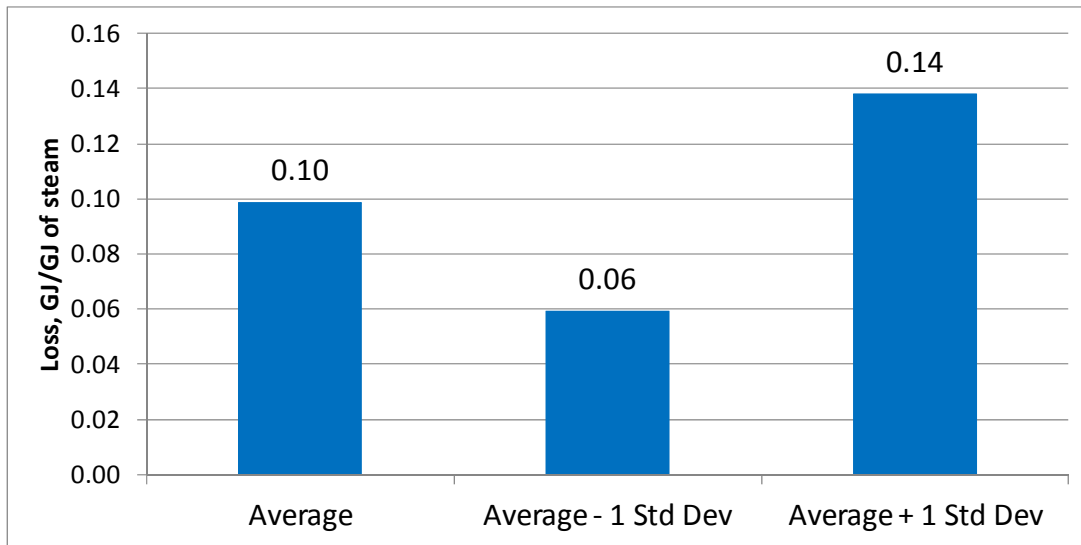
Figure 4.24 shows the relationship between glycol loss and glycol air cooler inlet temperature for all SAGD sites. Although there is a slight positive slope, as we would expect for glycol loss vs. glycol cooler temperature, the correlation is very weak. However, the correlation is better for individual site data and the results show the expected positive slope between glycol loss and glycol cooler inlet temperature for all but one of the SAGD sites, whose outlet temperature from the glycol cooler varied significantly with the seasons.

**Figure 4.24**  
**Glycol Losses vs. Glycol Cooler Inlet Temperature—SAGD Only**



While we could not show data points for glycol loss that included losses from the CSS glycol system we did include this data in generating average losses from the CPF shown in Figure 4.25. The average loss is similar to the loss for SAGD sites only; the standard deviation is somewhat smaller as a result of including the CSS data.

**Figure 4.25  
Glycol Loss—All Sites**



## OTSG Stack Losses

Figure 4.26 shows the average OTSG stack loss per GJ of OTSG steam  $\pm$  one standard deviation. The standard deviation is 0.02 GJ/GJ of OTSG steam, which is 20% of the average value of 0.09 GJ/GJ of OTSG steam.

**Figure 4.26**  
**OTSG Stack Loss—All Sites**

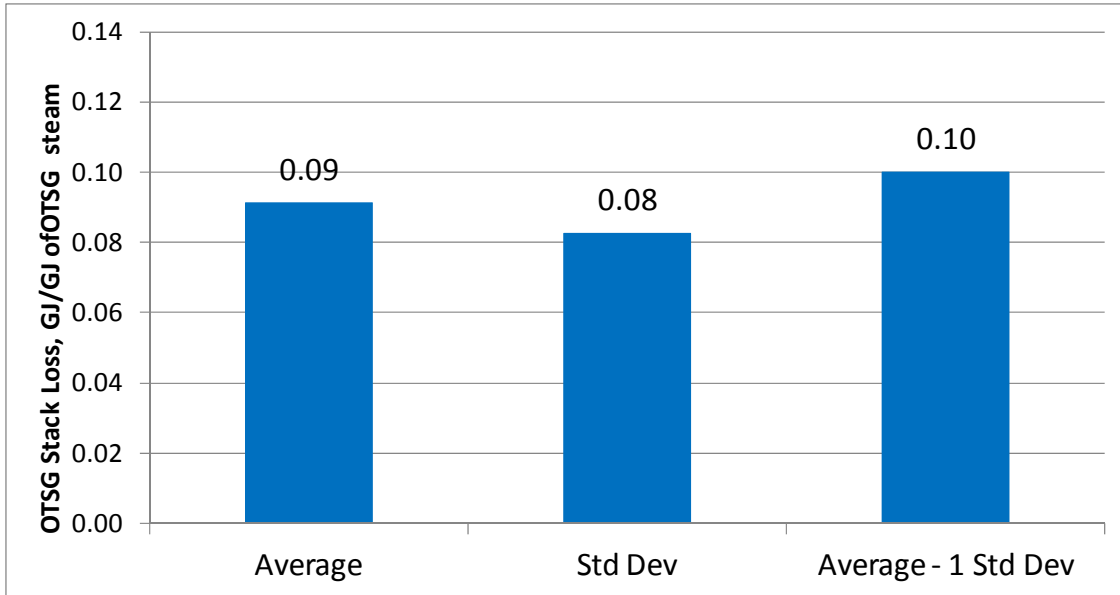
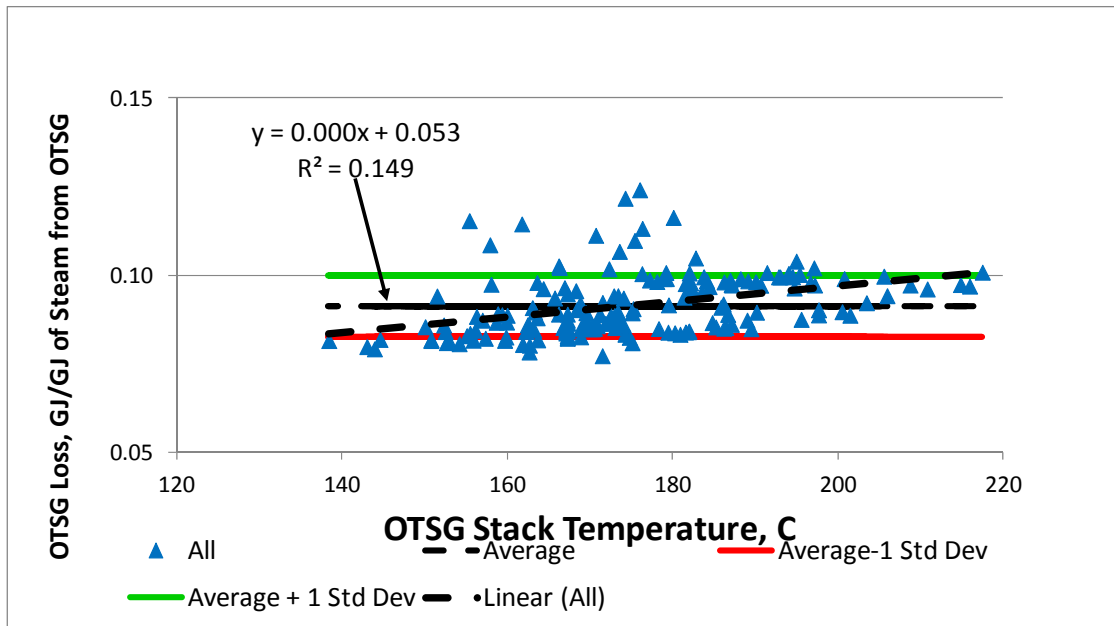


Figure 4.27 shows OTSG stack loss vs. OTSG stack temperature for all sites. The expected relationship is that stack loss will increase with increasing stack temperature. The data show poor correlation; included in the figure is the average value for stack loss for all the data and  $\pm$  one standard deviation. This may indicate that excess oxygen is varying as stack temperatures vary, but not necessarily in the same direction. However, data from several individual sites do show, as expected, stack loss increasing with increasing stack temperature.

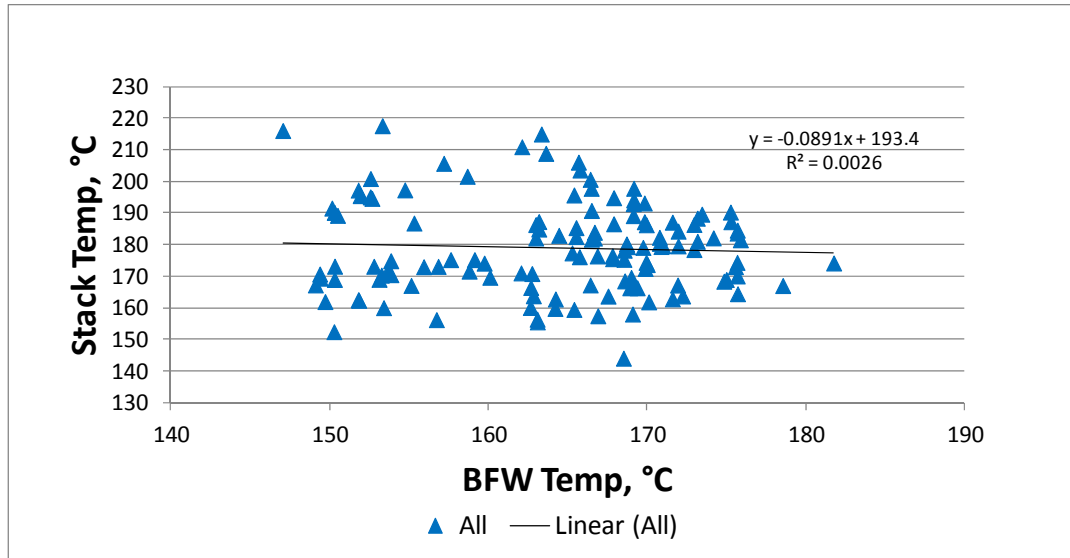
Figure 4.27  
OTSG Stack Loss vs. OTSG Stack Temperature—All Sites



## OTSG Stack Temperature

We expect an inverse relationship between stack temperature and BFW temperature. However, this will depend on the location of measurement and how close the temperature approach is for the site. Figure 4.28 shows all data points for OTSG stack temperature vs. OTSG BFW temperature for SAGD sites. A clear relationship cannot be seen, nor could one be seen for data for an individual site. This may be due to the proximity to the BFW and stack temperature cross and/or to the locations of the BFW and stack temperature measurement, upstream or downstream of flue gas/BFW heat exchange. As previously mentioned, we opine that the reported BFW temperatures and possibly the stack temperatures may not be accurate for several sites due to inconsistencies in measurement and/or measurement location.

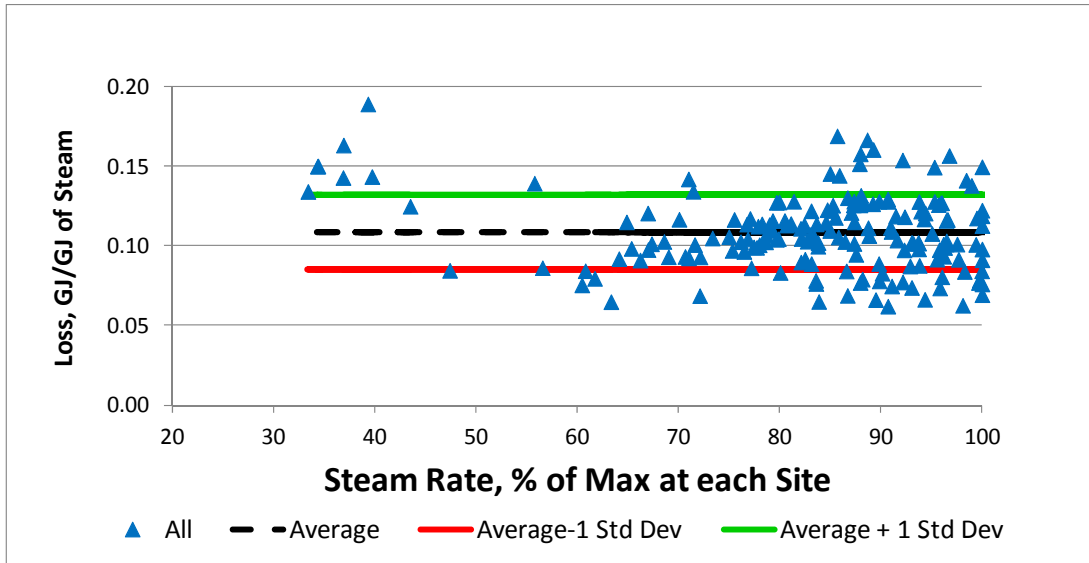
**Figure 4.28**  
**OTSG Stack Temperature vs. OTSG BFW Temperature—SAGD Sites**



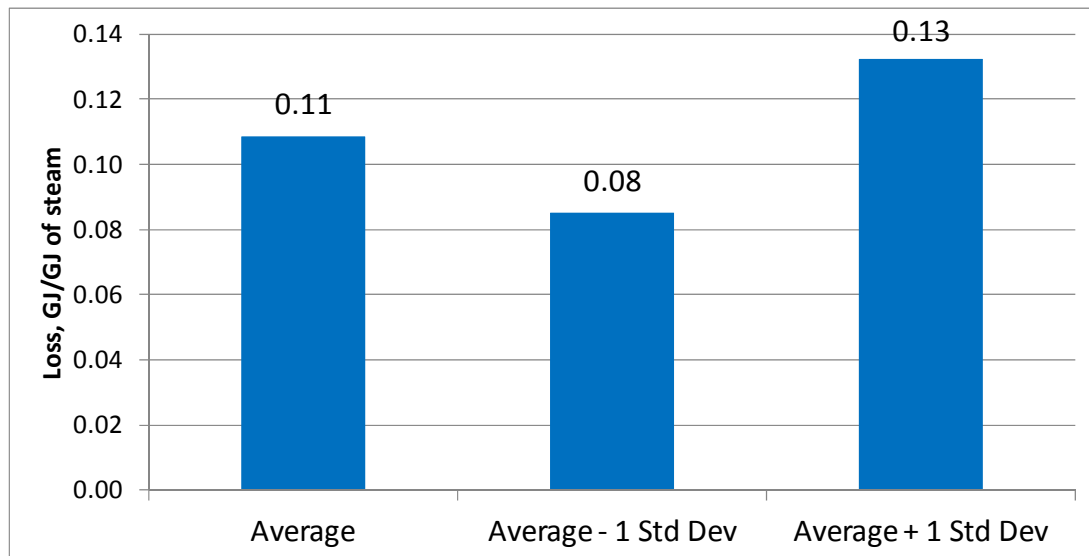
## Stack + Electricity Losses

As previously discussed, stack and electricity losses must be considered together when comparing across multiple sites due to differences in the way losses are calculated at sites with and without cogeneration. Figure 4.29 shows losses from the stack plus electricity. Figure 4.30 shows the average sum of stack plus electricity losses per GJ of steam across all sites. The average stack plus electricity losses are 0.11 GJ/GJ of steam, and the standard deviation is 0.02 GJ/GJ of steam, which is 22% of the average. Figure 4.31 shows the histogram for stack plus electricity loss, which is centered on 0.11 GJ/GJ of steam.

**Figure 4.29**  
**Stack + Electricity Losses vs. Steam Rate—All Sites**

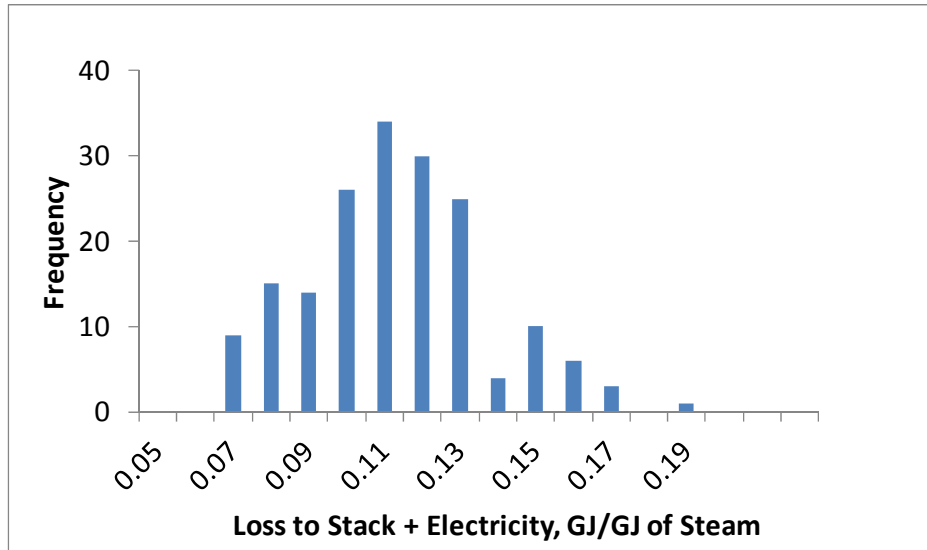


**Figure 4.30**  
**Stack + Electricity Losses—All Sites**





**Figure 4.31**  
**Stack + Electricity Losses Histogram—All Sites**

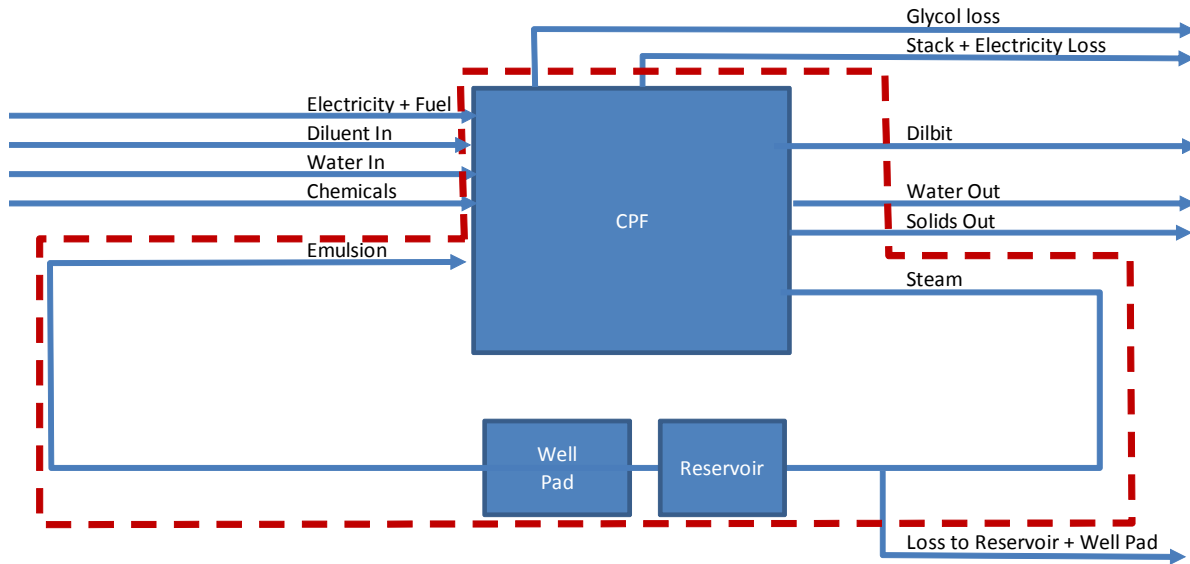


## CPF Losses to Reservoir and Well Pad + Other Energy Differences

The results show that the energy to produce a GJ of steam is 1.01 GJ/GJ of steam with a standard deviation of 0.06 GJ/GJ of steam, which is 6% of the average. Energy consumption includes the energy in the fuel imported into the CPF to produce steam as well as the energy used to generate the electricity used in the CPF to move fluids. The fuel for electricity generation is either fuel imported for cogeneration or fuel used to generate electricity on the Alberta grid. For grid-based electricity, a line loss term is included in determining the fuel required.

The energy balance around the CPF, first introduced in Figure 1.1, can be simplified as shown in Figure 4.32.

Figure 4.32  
CPF Energy Balance



The major equations are shown in the following expression:

$$1. E_{(\text{Electricity} + \text{Fuel})} + E_{\text{Water In}} + E_{\text{Chemicals}} + E_{\text{Diluent}} = \text{LOSS}_{(\text{Glycol and to Stack} + \text{Electricity})} + E_{\text{Dilbit}} + E_{\text{Water Out}} + E_{\text{Solids Out}} + \text{LOSS}_{(\text{Reservoir} + \text{Well Pad})}$$

If we assume that the energy in the chemicals used in the CPF is the same as the energy in the solids that are disposed, we can generate the following equation for the loss to the reservoir and well pad:

$$2. \text{LOSS}_{(\text{Reservoir} + \text{Well Pad})} + E_{\text{Dilbit}} - E_{\text{Diluent}} + E_{\text{Water Out}} - E_{\text{Water In}} = E_{(\text{Electricity} + \text{Fuel})} - \text{LOSS}_{(\text{Glycol and to Stack} + \text{Electricity})}$$

$$3. \text{Other Energy Differences} = E_{\text{Dilbit}} - E_{\text{Diluent}} + E_{\text{Water Out}} - E_{\text{Water In}}$$

$$4. \text{LOSS}_{(\text{Reservoir} + \text{Well Pad})} + \text{Other Energy Differences} = E_{(\text{Electricity} + \text{Fuel})} - \text{LOSS}_{(\text{Glycol and to Stack} + \text{Electricity})}$$

The terms on the right side of Equation 4 are the energy used in the CPF minus the quantifiable losses. Table 4.1 shows the average values for these terms, including their standard deviations.

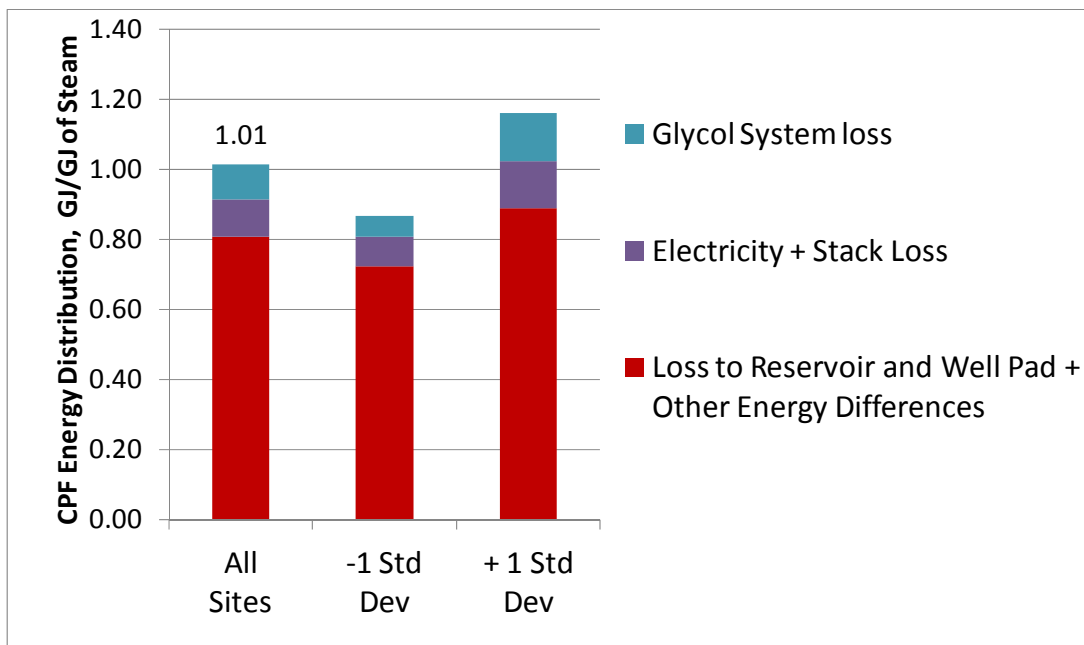
**Table 4.1**  
**CPF—Losses to Reservoir + Well Pad + Other Energy Differences**

	All Sites Average	Standard Deviation All Sites
	per GJ of Steam	per GJ of Steam
Fuel Consumption	1.01	0.06
Electricity + Stack Loss	0.11	0.02
Glycol System Loss	0.10	0.04
Loss to Reservoir and Well Pad + Other Energy Differences	0.81	0.08

\* Loss to Reservoir and Well Pad + Other Energy Differences =  
 Energy(Electricity + Fuel) - Losses (Glycol and to Stack + Electricity)

The energy used in the CPF minus the quantifiable losses for all sites are shown in Figure 4.33 for the results on average. The number above the bar in Figure 4.33 represents the energy consumption in the CPF from fuel and electricity. The two additional bars in Figure 4.33 are based on ± one standard deviation from the average values shown in the left most bar, which shows glycol loss, electricity +stack loss, and loss to reservoir and well pad. The variation in losses is significant.

**Figure 4.33**  
**Energy and Losses in CPF—All Sites on Average**



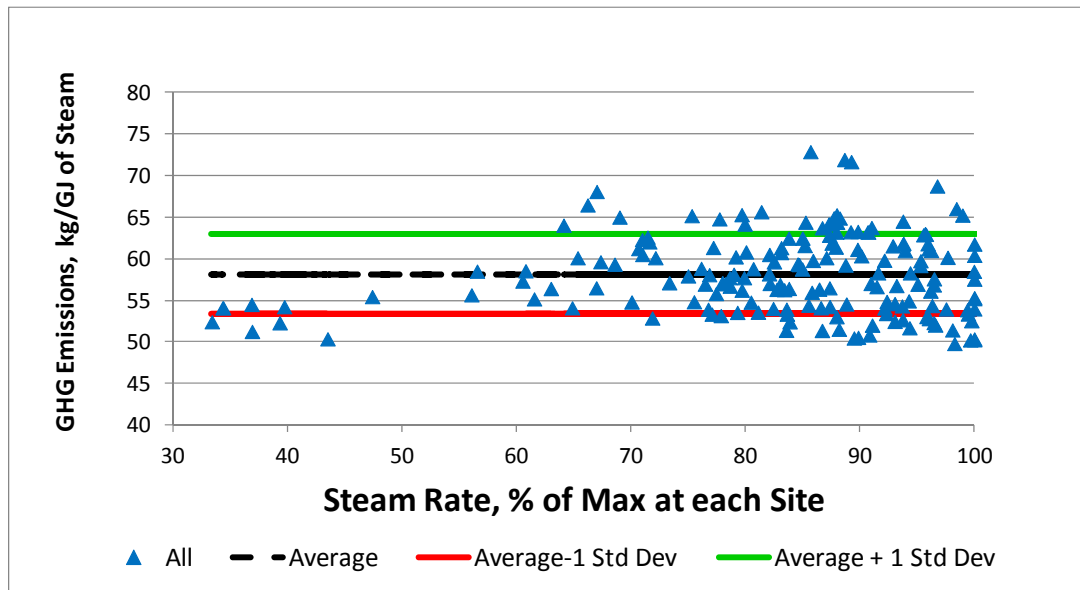
# GHG Emissions

GHG emissions from bitumen production are strongly dependent on the energy consumption in the CPF and on the type of energy consumed. Natural gas has much lower GHG emissions than syngas (see Table 3.6). Grid-based electricity has much higher GHG emissions than cogenerated electricity. In addition, the efficiency of steam generation from cogen is higher than the efficiency from an OTSG. We will first look at GHG emissions per unit of steam and then we will look at GHG emissions per barrel of bitumen.

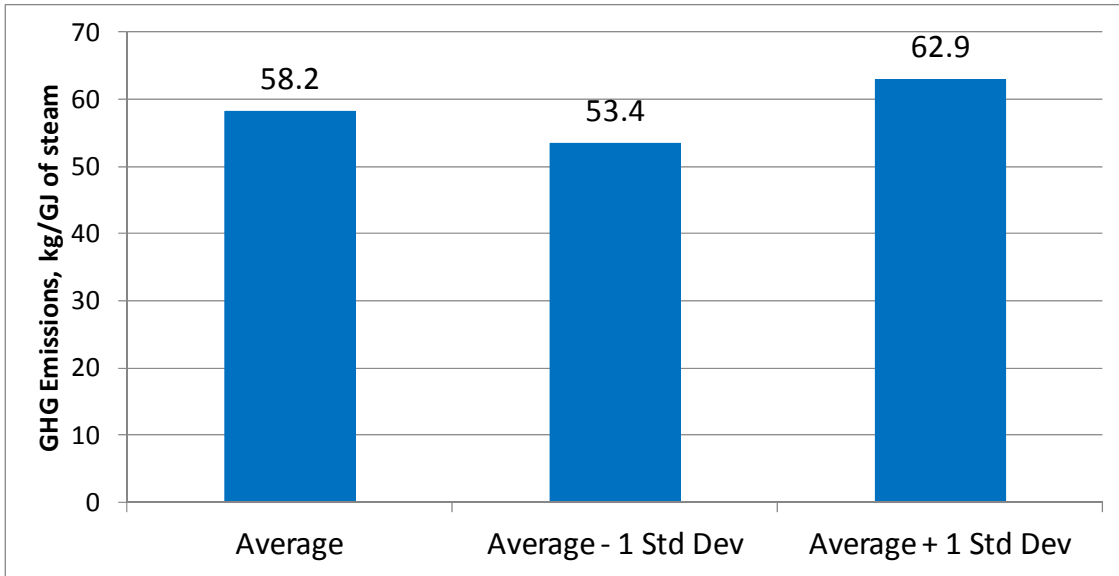
## GHG Emissions per GJ of Steam

Figure 4.34 shows the GHG emissions per GJ of steam for all sites that use only natural gas and produced gas. For this analysis, for sites that use syngas, we used the GHG intensity of natural gas in place of the GHG intensity of syngas. As seen in Figure 4.35, the average GHG emissions for these sites is 58.2 kg CO<sub>2</sub>/GJ of steam, with a standard deviation of 4.8 kg CO<sub>2</sub>/GJ of steam, which is 8% of the average. Figure 4.36 shows the histogram of GHG emissions data for these sites centered around 56-60 kg CO<sub>2</sub>/GJ of steam.

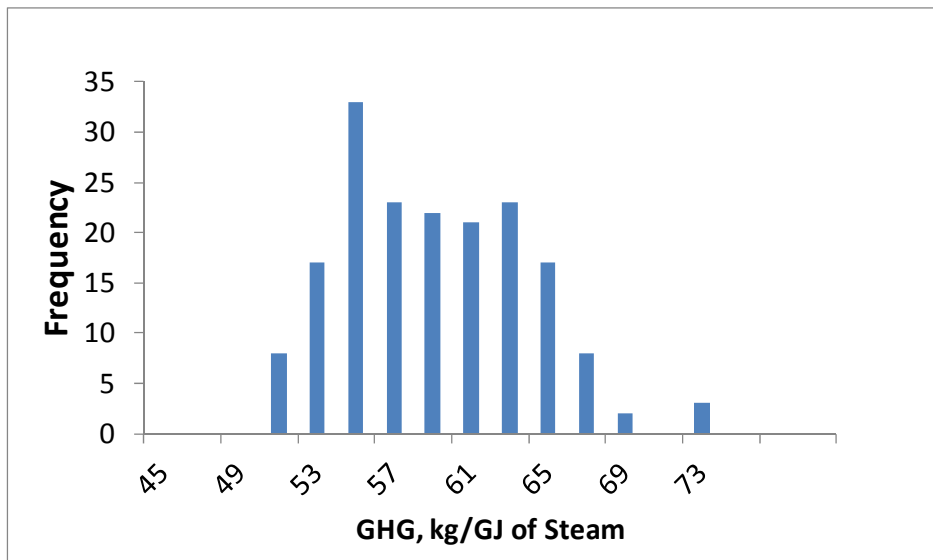
**Figure 4.34**  
**GHG per GJ of Steam vs. Steam Rate—All Sites, Syngas Replaced with Natural Gas**



**Figure 4.35**  
**GHG per GJ of Steam—All Sites, Syngas Replaced with Natural Gas**



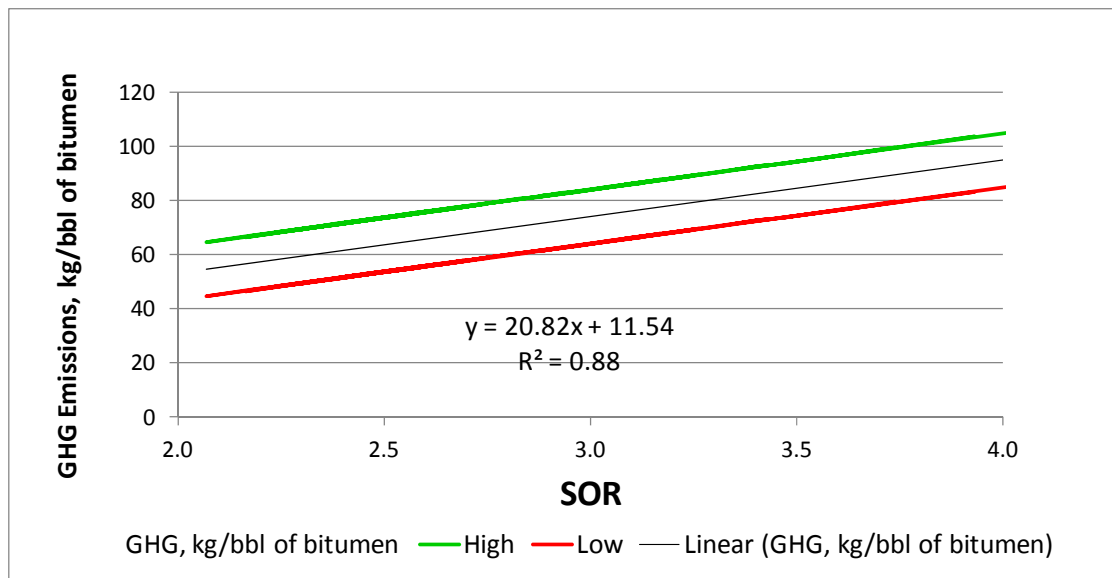
**Figure 4.36**  
**GHG per GJ of Steam Histogram—All Sites, Syngas Replaced with Natural Gas**



## GHG Emissions per Barrel of Bitumen

We plotted GHG emissions per barrel of bitumen vs. SOR in Figure 4.37 for all SAGD sites that use only natural gas and produced gas. We replaced the GHG intensity of syngas with the GHG intensity of natural gas for sites using syngas. All data points fall within the green and red lines, which do not represent  $\pm$  one standard deviation from the average. The data span is  $\pm 10$  kg CO<sub>2</sub>/bbl of bitumen. To preserve data confidentiality, the data points are not shown.

**Figure 4.37**  
**GHG Emissions vs. SOR—All SAGD Sites, Syngas Replaced with Natural Gas**



We next compared GHG emissions per barrel of bitumen between SAGD sites that use natural gas and produced gas only. To do this, we used the slope of the trend line from Figure 4.34 to normalize the GHG emissions for each data point at the operating SOR to the theoretical GHG emissions if the SOR were 3.0.

As seen in Figure 4.38, the average GHG emissions per bbl of bitumen at a nominal 3 SOR is 74 kg CO<sub>2</sub>/bbl of bitumen for all the SAGD sites using natural gas and produced gas. The standard deviation is 5.5 kg CO<sub>2</sub>/bbl, which is 7% of the average.

These results assume that the relationship between GHG emissions and SOR is the same for all SAGD sites and there are no differences in design or operation of the different sites.

**Figure 4.38**  
**Normalized GHG per bbl of Bitumen at 3.0 SOR—All SAGD Sites, Syngas Replaced with Natural Gas**

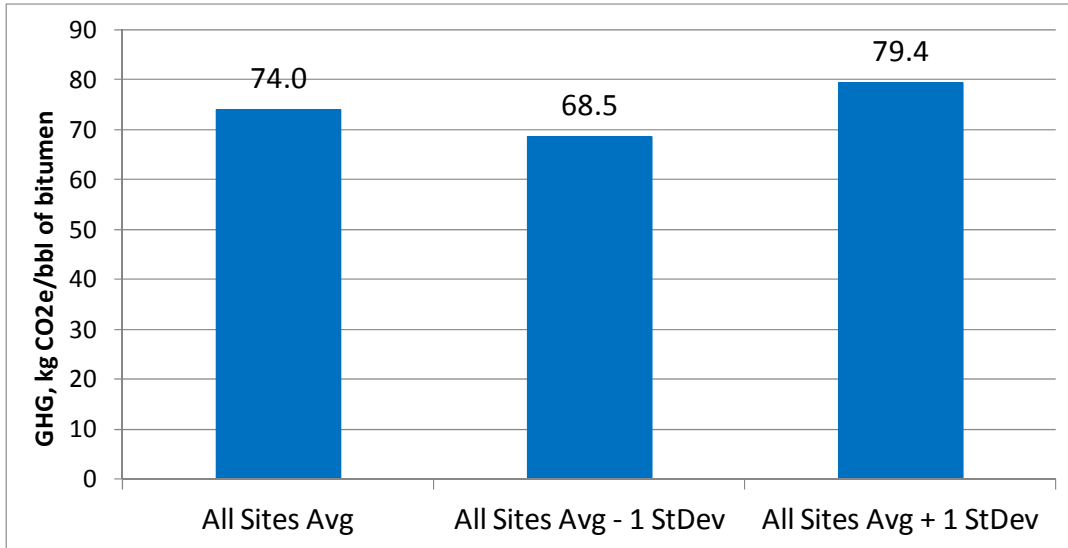
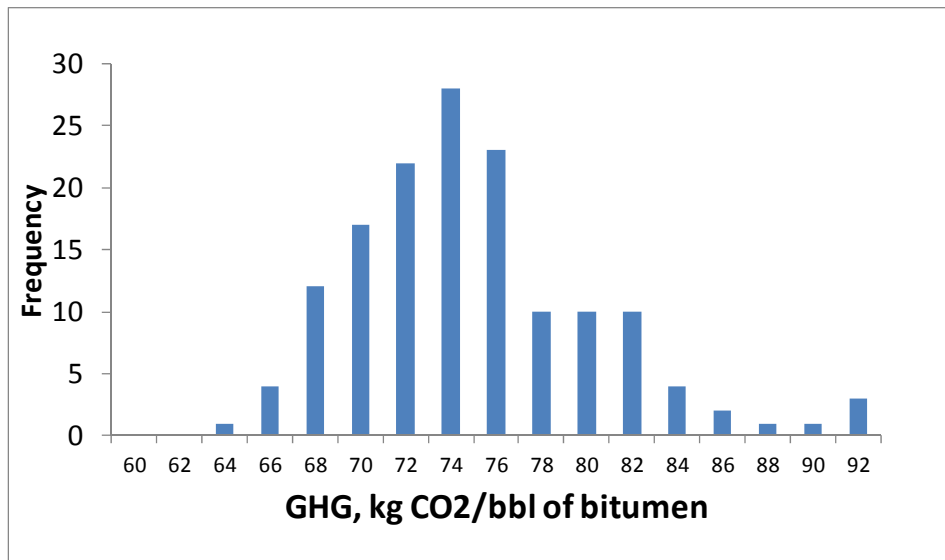


Figure 4.39 shows the histogram for GHG emissions normalized to 3.0 SOR.

**Figure 4.39**  
**Histogram of Normalized GHG per bbl of Bitumen at 3.0 SOR—All SAGD Sites, Syngas Replaced with Natural Gas**



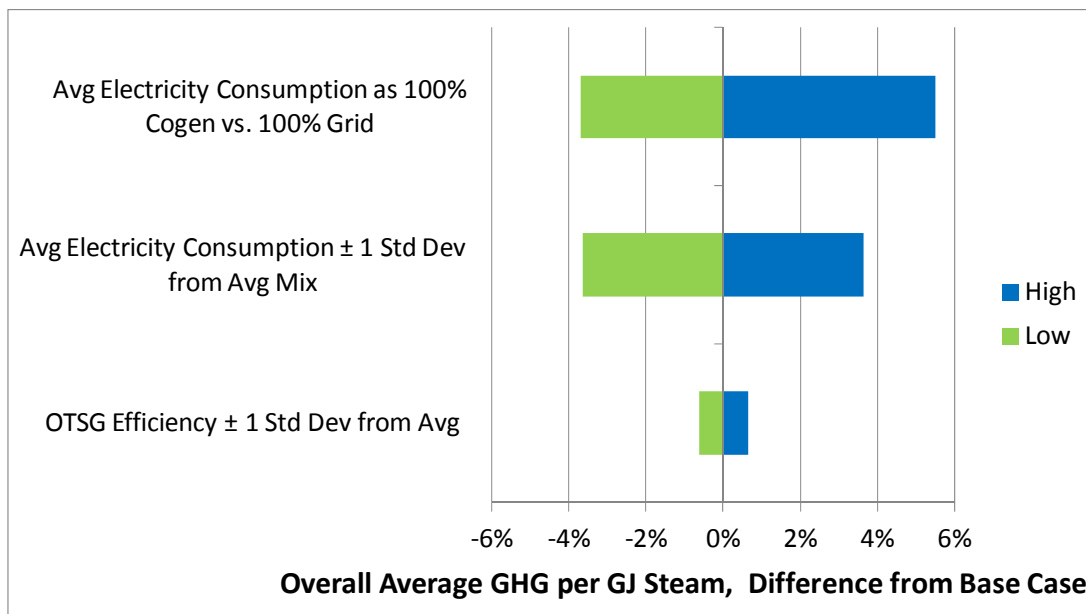
## Major Factors Affecting GHG Emissions

One of the objectives of this Study was to identify parameters that affect GHG emissions in order to help the industry determine priorities for GHG emission reduction.

### Impact of Electricity Source and OTSG Efficiency on GHG Emissions

Parameters can be isolated to perform a sensitivity analysis of their effect on total GHG emissions. Figure 4.40 shows the relative change in CPF GHG emissions on average from changing electricity source or OTSG efficiency.

**Figure 4.40**  
**Tornado Diagram—Effects on GHG Emissions of Changing a Single Variable**



- In the Study, the electricity consumed for all sites on average is a mix of grid-based electricity and cogen. The top bar in Figure 4.40 shows the impact of changing electricity GHG intensity from the average electricity mix to one that is 100% cogen. The results show an overall GHG emissions reduction of 3.7% (the bar on the figure marked Low). If the average electricity mix were instead replaced by 100% grid-based electricity, the GHG emissions would increase by 5.5% (the bar on the figure marked High).

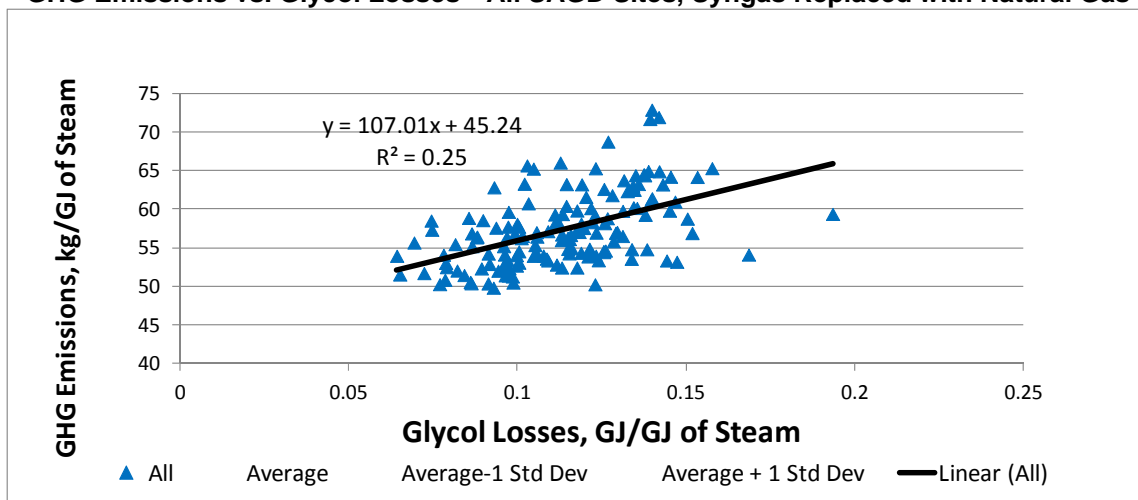


- The middle bar in Figure 4.40 shows a 3.6% variation in overall GHG emissions based on one standard deviation in average electricity consumption. A site with above-average energy consumption may see significant GHG emissions reduction using cogenerated electricity. However, a site with below-average energy consumption will see less benefit from cogeneration.
- The bottom bar in Figure 4.40 shows the change in total GHG emissions for a site with an OTSG efficiency equal to the average  $\pm$  one standard deviation. The variation in OTSG efficiency across the sites is less than 1%; therefore, improving OTSG efficiency by one standard deviation will have limited benefit.

## GHG Emissions vs. Glycol Losses

CPF GHG emissions vs. glycol losses are shown in Figure 4.41. Data for sites using syngas have been adjusted to substitute the GHG intensity of natural gas for the GHG intensity of syngas. There is weak correlation of GHG emissions vs. glycol loss in Figure 4.41. The results are better correlated for individual sites.

**Figure 4.41**  
**GHG Emissions vs. Glycol Losses—All SAGD Sites, Syngas Replaced with Natural Gas**

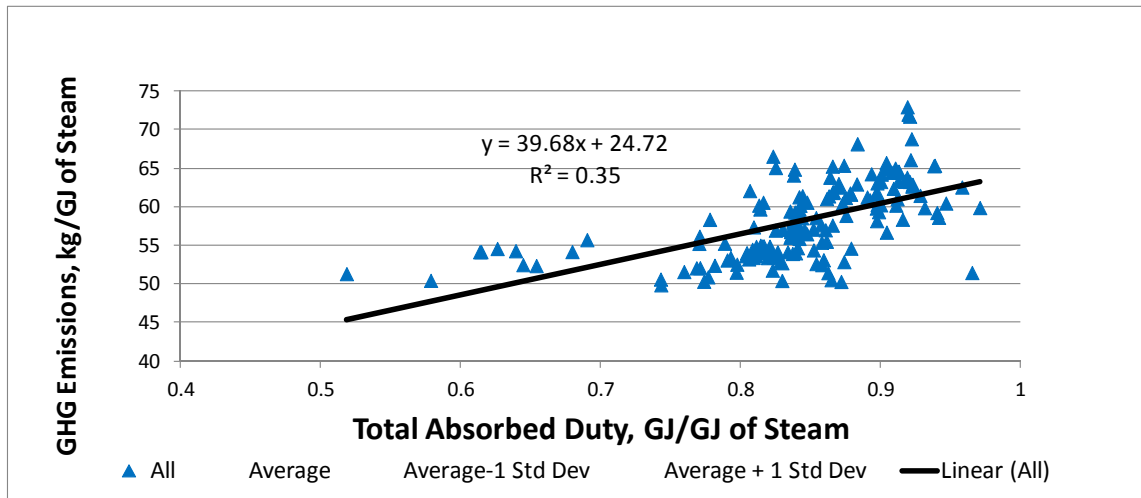


## GHG Emissions vs. Absorbed Duty

CPF GHG emissions vs. total absorbed duty in all steam generators that use natural gas and produced gas are shown in Figure 4.42. Data for sites using syngas are included, as we substituted the GHG intensity of natural gas for the GHG intensity of syngas. The correlation is slightly better than for GHG emissions vs. glycol loss, perhaps because of the high-efficiency

production of steam in cogeneration units. The results show a general trend of increasing GHG emissions with higher absorbed duty in steam generation (less efficient generation). However, the correlation is weak.

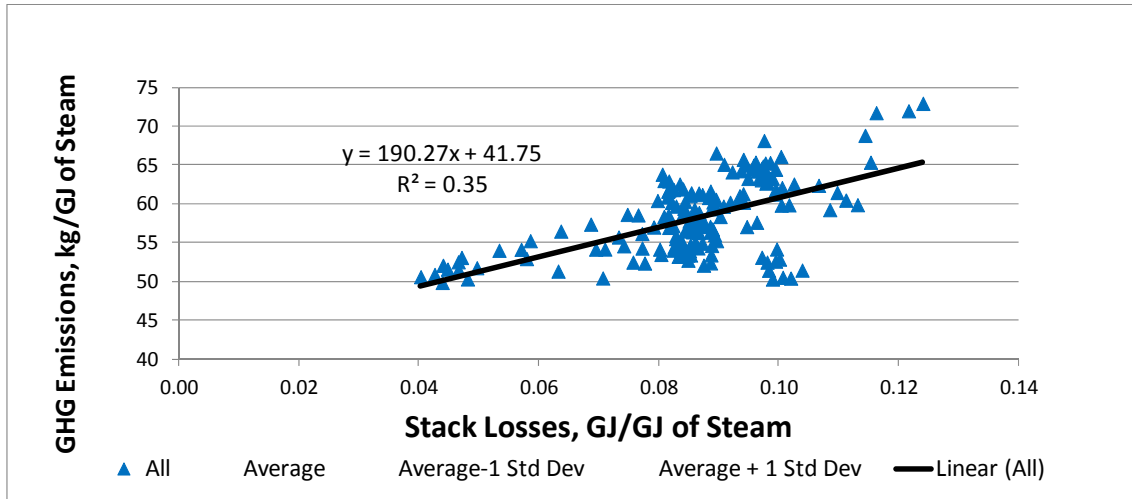
**Figure 4.42**  
**GHG Emissions vs. Absorbed Duty—All Sites, Syngas Replaced With Natural Gas**



## GHG Emissions vs. OTSG Stack Losses

CPF GHG emissions vs. OTSG stack losses are shown in Figure 4.43. This correlation includes only sites using natural gas and produced gas; data from sites using syngas were adjusted by substituting the GHG intensity of natural gas for the GHG intensity of syngas. OTSG stack losses are a function of both OTSG efficiency and also absorbed duty per GJ of steam (effectively, the amount of preheating of BFW and thus the amount of heating required in the steam generator to generate the steam). Again, a relationship can be seen between OTSG stack losses and GHG emissions. However, the relative range of values for stack losses is wider than the range of values for absorbed duty, which also shows the effect of OTSG efficiency on stack loss. The correlation is weak.

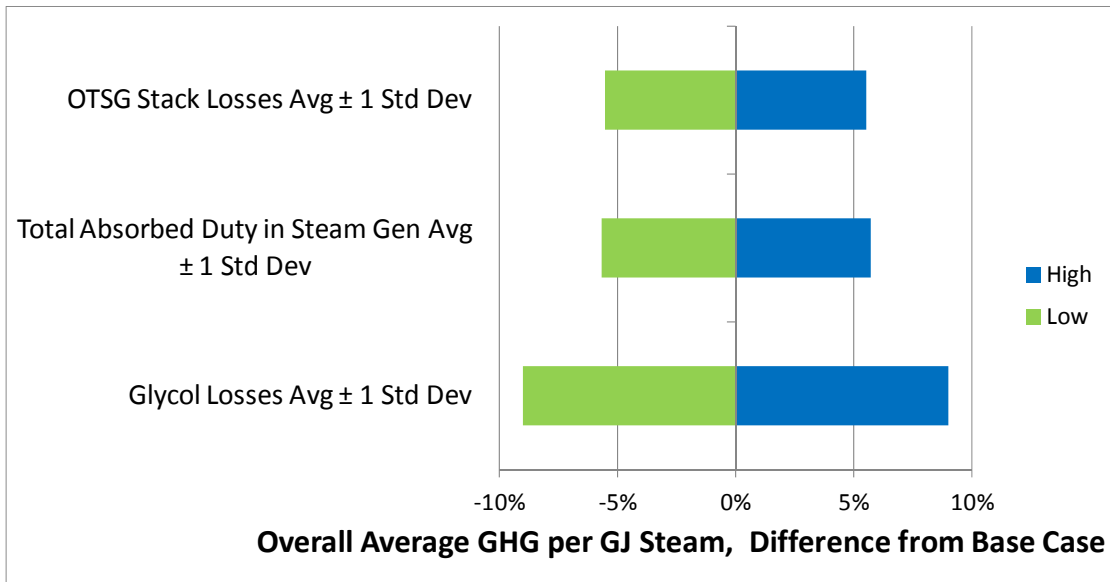
**Figure 4.43**  
**GHG Emissions vs. OTSG Stack Losses—All Sites, Syngas Replaced with Natural Gas**



## Impact on GHG Emissions

We applied the correlations for each parameter described above to the average GHG emissions for all sites  $\pm$  one standard deviation of each parameter (High/Low Cases). This analysis is for sites that use only natural gas and produced gas. It is meant to be indicative and not causative, because it is not possible to isolate the effect of only one parameter on GHG emissions from the CPF. For example, glycol loss is connected to overall plant design and cannot be independently isolated. Instead, Figure 4.44 shows the general trend of GHG emissions when one parameter was changed  $\pm$  one standard deviation from the average.

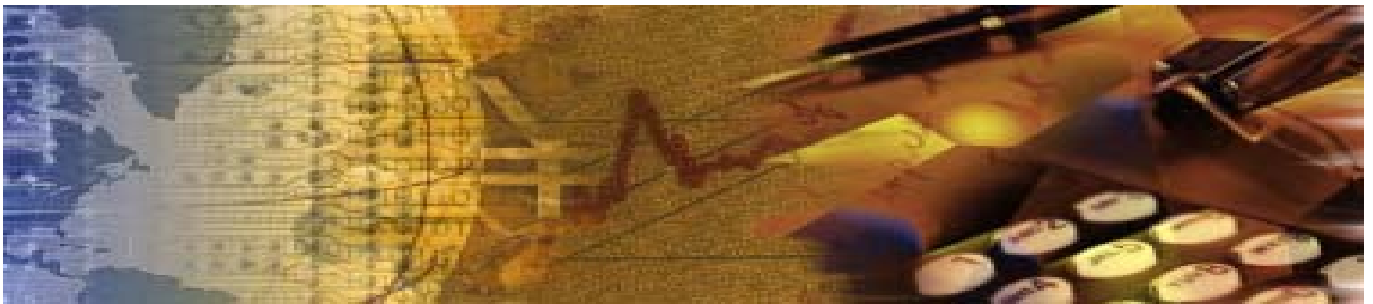
**Figure 4.44**  
**Change in GHG Emissions Using Correlations of Major Factors**



- Varying OTSG stack loss  $\pm$  one standard deviation has about the same effect on GHG emissions as varying steam absorbed duty  $\pm$  one standard deviation.
- Varying glycol loss one standard deviation has a larger impact than from varying the other parameters.

—This page intentionally blank—

## Section 5.



## Conclusions

## Benchmarks

- Benchmarks were put on the basis of a GJ of steam generated in order to eliminate the effect of the reservoir and also eliminate the effect of steam properties. By using this basis, we can compare results from all sites irrespective of the steam-to-oil ratio (SOR) or steam quality. Steam-to-oil ratio is the ratio of the cold-water-equivalent volume of steam (condensate) to the volume of bitumen produced. Thus, sites that must operate at higher SOR to produce bitumen because of reservoir geology may be compared with sites that can operate with lower SOR. Also, sites that inject a water-steam mixture (CSS sites) can be compared with sites that inject dry steam (SAGD sites). In addition, the effect of steam pressure is eliminated because the comparison uses steam enthalpy from steam tables.
- The average OTSG efficiency for all sites is 90.4% on a lower heating value (LHV) basis with a standard deviation of 0.7%, which is 0.7% of the average.
- The average energy consumption is 1.01 GJ (LHV) per GJ of steam for all sites and the standard deviation is 0.06 GJ/GJ of steam, which is 6% of the average.
- There is a significant difference in electricity consumption between sites: 8.3 kWh/GJ of steam, with a standard deviation of 3.1 kWh/GJ of steam, which is 38% of the average.
- The average total loss (stack loss + electricity loss + glycol system loss) is 0.21 GJ/GJ of steam and the standard deviation is 0.05 GJ/GJ of steam, which is 27% of the average. For SAGD sites, the magnitude of glycol loss is approximately equal to the magnitude of stack + electricity loss.
- The average glycol loss is 0.10 GJ/GJ of steam for all sites, and the standard deviation is 0.04 GJ/GJ of steam, which is 40% of the average. When only the SAGD sites are included in the evaluation, the average loss is 0.11 GJ/GJ of steam with a standard deviation of 0.02 GJ/GJ of steam, which is 18% of the average.
- Stack and electricity losses must be considered together when comparing between sites due to the difference in the way losses are calculated for sites with and without cogeneration. The average stack + electricity loss from all sites is 0.11 GJ/GJ of steam with a standard deviation of 0.02 GJ/GJ of steam, which is 22% of the average.
- The average of the GHG emissions for all sites is 58.2 kg CO<sub>2</sub>/GJ of steam, with a standard deviation of 4.8 kg CO<sub>2</sub>/GJ of steam, which is 8% of the average. For this estimate, we assumed natural gas GHG intensity for syngas.
- The average GHG emissions normalized to 3 SOR for the SAGD sites are 74 kg CO<sub>2</sub>/bbl of bitumen with a standard deviation of 5.4 kg CO<sub>2</sub>/bbl, which is 7% of the average. For this estimate, we assumed natural gas GHG intensity for syngas.

## Observations

- SOR is by far the biggest driver of GHG emissions and energy intensity. However, there are CPF operators that operate with higher efficiency than others.
- Preliminary evaluation of efficiency points to differences in facility design as opposed to variability in operations/maintenance. Overall, consistency in operation at a site was not necessarily an indicator of good performance in terms of energy consumption and GHG emissions. However, sites that demonstrated greater variability in performance tended to show greater variability in energy consumption and GHG emissions.
- OTSG efficiency is similar between sites. The narrow variability in OTSG efficiency indicates that although steam generation is the primary energy consumer in the CPF, variance within the range of OTSG efficiencies in the Study does not significantly affect GHG emissions. Thus, variability in OTSG stack losses is primarily due to variability in steam absorbed duty rather than variability in OTSG efficiency.
- Electricity consumption varied significantly between sites. The method of electricity generation and intensity of electricity consumption per GJ of steam has a small but not insignificant impact on GHG emissions.
- Better recovery of heat will lead to lower energy consumption and lower GHG emissions. Using electric submersible pumps in place of gas lift to recover the bitumen-water emulsion from the reservoir will reduce energy use and GHG emissions at the CPF because more energy in the emulsion can be recovered. Reducing losses to the glycol system will lead to lower energy consumption and GHG emissions.
- Using on site cogenerated steam and electricity leads to lower GHG emissions than using grid-based electricity and generating steam in an OTSG because cogenerated steam and electricity generation are more efficient and the natural gas fuel is lower in GHG emissions than the fuels used to generate electricity for the grid.
- Variability in overall quantifiable losses is primarily due to variability in glycol system loss and stack loss, indicating differences in configuration, losses, and energy recovery from the emulsion.
- We did not see the expected relationships between BFW temperature and energy consumption or between BFW temperature and steam absorbed duty. We suggest that this indicates that the measurement of one or more parameters, likely BFW temperature, is not accurate enough for a correlation to be observed at most sites and is a result of inconsistency in the location of measurement or that the water economizers on the boilers offset differences in BFW preheat. We recommend sites examine the placement and accuracy of BFW temperature measurement.



—This page intentionally blank—

# References

---

## References

- (1) Mochinaga, H, Properties of Oil sands and Bitumen in Athabasca, Japan Petroleum Exploration Co., 2006 CSPG, CSLG CWLS Conference
- (2) Handbook of Aviation Fuel Properties, Section 2, page 22, Coordinating Research Council, 1983.
- (3) Chang Ai-Fu, Pashikanti, K, Liu, Y.A. Refinery Engineering: Integrated Process Modeling and Optimization, Published Online: 10 APR 2013, Chapter 1. Characterization, Physical and Thermodynamic Properties of Oil Fractions, Published Online: 10 APR 2013 DOI: 10.1002/9783527666836.ch1, <http://onlinelibrary.wiley.com/doi/10.1002/9783527666836.ch1/pdf>
- (4) Speight J.A. Chemistry and Technology of Petroleum 4<sup>th</sup> edition, CRC Press, 2007, page 259
- (5) Ethylene Glycol water mixtures heat capacity and density [http://www.engineeringtoolbox.com/ethylene-glycol-d\\_146.html](http://www.engineeringtoolbox.com/ethylene-glycol-d_146.html)
- (6) Tri ethylene glycol mixture: HYSYS glycol package to generate density and heat capacity for different mixtures in water
- (7) Water properties: [http://www.thermexcel.com/english/tables/eau\\_atm.htm](http://www.thermexcel.com/english/tables/eau_atm.htm)
- (8) Steam properties: <http://www.spiraxsarco.com/us/resources/steam-tables/saturated-steam.asp>
- (9) AESO electricity generation and supply to the grid: 2013 Annual Market Statistics, AESO (Alberta Electricity System Operator), 2014
- (10) Heat Rates for Power - Alberta 10 Year Generation Outlook, Prepared for Alberta Electric System Operator, AMEC Americas, October, 2006
- (11) Line loss in Alberta: AESO - Final\_Alberta\_Loss\_Factors\_for\_2011.pdf [http://www.aeso.ca/downloads/Final\\_Alberta\\_Loss\\_Factors\\_for\\_2011.pdf](http://www.aeso.ca/downloads/Final_Alberta_Loss_Factors_for_2011.pdf)
- (12) Heat Rates for simple and combined cycle gas powered electricity generation: <http://www.powerauthority.on.ca/current-electricity-contracts/sc-cc>
- (13) Heating values, Hydrogen Analysis Resource Center: Lower and Higher Heating Values of Hydrogen and Fuels, GREET Transportation Fuel Cycle Analysis Model, GREET 1.8b
- (14) Heat Rate for Biomass: Renewable Electricity Futures Study, Volume 2: Renewable Electricity Generation and Storage Technologies, National Renewable Energy Laboratory, June 2012
- (15) GHG emissions for fuels: Trends in GHG Emissions in the Alberta Electricity Market Impact of fuel switching to natural gas, Report for Independent Power Producers Society of Alberta, EDC Associates Ltd., May-13

# Appendix

---

## Data Requested from Study Participants

## COSIA Energy Thermal In Situ Benchmarking

### Data Required

To conduct this Study we will require the following:

***Daily Average Data Taken for 3 years—Data Taken after Start-Up (Include Tag No. and description of Tag No.)***

1. SOR and bitumen production rate
2. Consumed Energy
  - a. Natural gas, GJ/month
  - b. Associated gas consumed, GJ/month
  - c. Other gas consumed (e.g. fuel gas), GJ/month
  - d. Electricity
    - i. Consumed, GJ
    - ii. Exported, GJ
3. Heat and material balance
  - a. Emulsion
    - i. Flowrate
    - ii. Estimated specific gravity
    - iii. Temperature leaving wells and well pads and entering CPF, °C
  - b. Produced Gas (if applicable)
    - i. Flowrate
    - ii. Estimated MW
    - iii. Temperature leaving wells and well pads and entering CPF, °C
  - c. Diluted Bitumen product
    - i. Flowrate, bbls/month or m<sup>3</sup>/month
    - ii. Estimated API gravity
    - iii. Temperature to Tank/pipeline, °C
    - iv. Temperature in Tank, °C
  - d. Water
    - i. In: Flow and temp, Metric tons/month, °C
    - ii. Out: Flow and temp (to disposal well or run off – flow and temp), Metric tons/month, °C
  - e. Diluent (flowrate and temperature) – Only battery limit flows, °C
    - i. In; Flow and temp, bbls/month or m<sup>3</sup>/month, °C
    - ii. Diluent Specific Gravity
    - iii. Out; only if any diluent is not leaving with the bitumen
  - f. Solids to disposal, kg/day, °C

- g. Sulfur production , kg/d
- h. Chemicals imported, type and quantity
- 4. Steam production leaving CPF and entering wells and well pads
  - a. Flow, Metric tons/month
  - b. Temperature, °C
  - c. Pressure, kPa

### **Equipment Efficiency Measurement**

- 1. Heater efficiency for each heater - Steam generation and glycol heater (if applicable)
  - a. Heater stack temp, °C
  - b. Heater stack % O<sub>2</sub>
  - c. Fired Duty
  - d. Steam Quality
- 2. Heat loss in all Glycol air coolers
  - a. Glycol Inlet and outlet temp to each air cooler, °C
  - b. Glycol flow rate to each cooler, m<sup>3</sup>/hr
  - c. Ambient T, °C
- 3. Boiler Feed Water
  - a. Flow, tons/month
  - b. Temperature, °C

### **Facility Description**

#### **DCS Screen Shots**

- 1. Lift mechanism – gas or electrical submersible pump
- 2. Cogeneration yes or no
- 3. Water preparation – lime softening or evaporation
- 4. Water disposal
- 5. Enhanced oil recovery – solvent or other method
- 6. Process Flow Diagrams / Piping and Instrument Diagrams for the CPF
- 7. Other

# JACOBS<sup>®</sup> Consultancy

## **Jacobs Consultancy**

*Member, Jacobs Engineering Group*

### **United States Offices:**

5995 Rogerdale Road  
Houston, Texas 77072  
832.351.7800 (phone)  
832.351.7887 (fax)

525 West Monroe  
Suite 1350  
Chicago, Illinois 60661  
312.655.9207 (phone)  
312.655.9706 (fax)

### **Canada Office:**

205 Quarry Park Boulevard SE  
Calgary, Alberta T2C 3E7 Canada  
403.258.6896 (phone)  
403.385.1543 (fax)

### **United Kingdom Office:**

Tower Bridge Court  
226 Tower Bridge Road  
London SE1 2UP  
United Kingdom  
+44 (0)20 7403 3330 (phone)  
+44 (0)20 7089 7750 (fax)

### **Netherlands Office:**

Plesmanlaan 100, 2332 CB Leiden  
P.O. Box 141, 2300 AC Leiden  
The Netherlands  
+31.71.582.7111 (phone)  
+31.71.582.7050 (fax)

[www.jacobsconsultancy.com](http://www.jacobsconsultancy.com)